

HEAT RECOVERY UNITS

ASPIRCOMFORT SERIES

- ➔ Vertical wall-installation
- ➔ Suitable for rooms up to 240 m²
- ➔ High output >91%
- ➔ Automatic by-pass



DESCRIPTION:

Dual flow ventilation unit with very high efficiency heat recovery unit, suitable for the controlled mechanical ventilation of residential and commercial buildings.

ASPIRCOMFORT recovers heat, which would otherwise be lost, from the extracted air and transfers it to the incoming air, thereby significantly increasing its temperature.

The impurities found in the fresh air are trapped in filters on the machine.

CHARACTERISTICS:

- Expanded polypropylene (EPP) external structure;
- Very high efficiency polyethylene (PE) cross flow heat exchangers;
- Heat recovery greater than 91%;
- Maximum flow rate 390 m³/h;
- High efficiency DC motors;
- 3-speed adjustment with manual control;
- 3-speed adjustment and "timer" function through radio remote control;
- Possibility of controlling the unit from multiple remote controls (maximum 20);
- Automatic by-pass;
- Automatic frost protection with automatic de-frost valve;
- Wall brackets included;
- Ø150mm internal and Ø180mm external connections;
- Intake and supply connections from the room also from below;
- Silencer Ø180mm L=500mm included;
- Easily inspectable G3 filters without removing the cover and without the use of tools;

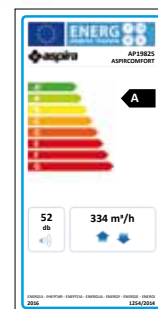

- Motor unit and electronic board inspected without detaching the unit from the ducts;
- BRE certification
- Compliant with Reg. (EU) 1254/2014

ACCESSORIES AND PARTS:

- Manual control
- RF Wireless Control
- G3 and F7 spare filters

DIMENSIONS

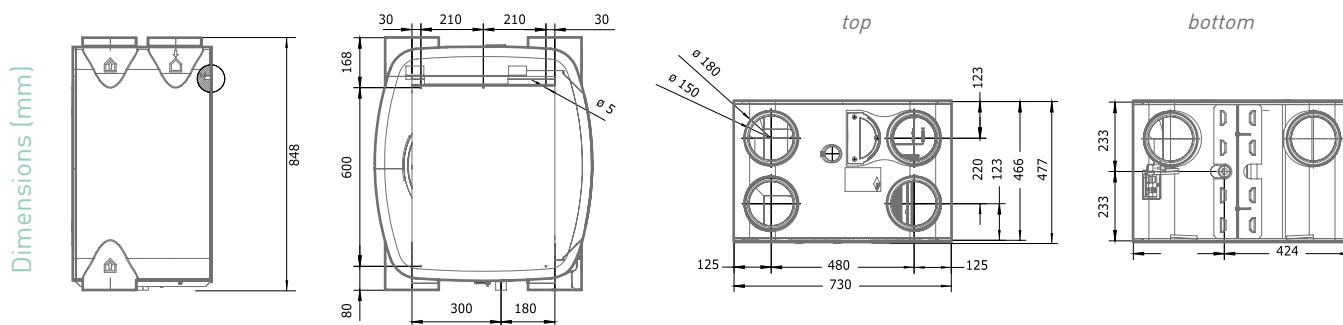

TECHNICAL FEATURES

CODE	MODEL	Control	m ³ /h	Pa	W	V~	Ph	Hz	IP	Kg
AP19825	ASPIRCOMFORT	(not included)	390	600	176	230	1	50	31	25

SPARE FILTER KIT

AP19976	FR 002	Kit of 2 G3 spare filters for ASPIRCOMFORT								
AP19977	FR 003	Kit of 2 F7 spare filters for ASPIRCOMFORT								

RADIO FREQUENCY SPEED REGULATOR (OPTIONAL)

AP19970	RDV-RF	Radio frequency remote control, 3 speeds + timer								
---------	--------	--	--	--	--	--	--	--	--	--



MANUAL SPEED REGULATOR (OPTIONAL)

AP19972	RDV-M	Manual control, 3 speeds								
---------	-------	--------------------------	--	--	--	--	--	--	--	--



PERFORMANCE

Possible configurations/performance

AIR FLOW RATE	m ³ /h	Pa	W	A	V	%	Ref. curves	
							Q	W
Mode 1 - Minimum	50	10	8	0.05	230	98	1	7
Mode 1 - Low (Preset)	75	20	12	0.1	230	98	2	8
Mode 2 - Medium	150	40	29	0.24	230	96.2	-	-
Mode 2 - Medium (Preset)	150	80	38	0.31	230	96.2	3	9
Mode 3 - High	225	100	74	0.59	230	94	-	-
Mode 3 - High (Preset)	225	150	88	0.69	230	94	4	10
Mode 3 - High	275	100	106	0.83	230	93	-	-
Mode 3 - High	275	150	126	0.99	230	93	5	11
Mode 3 - Maximum	325	100	156	1.22	230	92	-	-
Mode 3 - Maximum	325	150	176	1.36	230	92	6	12

RESULTS FROM SAP CALCULATION (STANDARD ASSESSMENT PROCEDURE)

RIGID DUCT SYSTEM (MINIMUM FLOW RATE)

Extraction terminal configuration	Fan speed control	Fan specific power (W/l/s)	Heat exchanger efficiency (%)	Energy savings compatible with best output
Kitchen + 1 service room	100% variable	0.46	91	Yes
Kitchen + 2 service rooms	100% variable	0.46	90	Yes
Kitchen + 3 service rooms	100% variable	0.50	88	Yes
Kitchen + 4 service rooms	100% variable	0.56	88	Yes
Kitchen + 5 service rooms	100% variable	0.65	87	Yes
Kitchen + 6 service rooms	100% variable	0.75	87	Yes
Kitchen + 7 service rooms	100% variable	0.87	87	Yes

RESULTS

AIR FLOW RATE	EXCHANGER OUTPUT IN %
54 m ³ /h – 15 l/s	91
75 m ³ /h – 21 l/s	90
97 m ³ /h – 27 l/s	88
119 m ³ /h – 33 l/s	88
140 m ³ /h – 39 l/s	87
162 m ³ /h – 45 l/s	87
184 m ³ /h – 51 l/s	87

CHARACTERISTIC CURVES

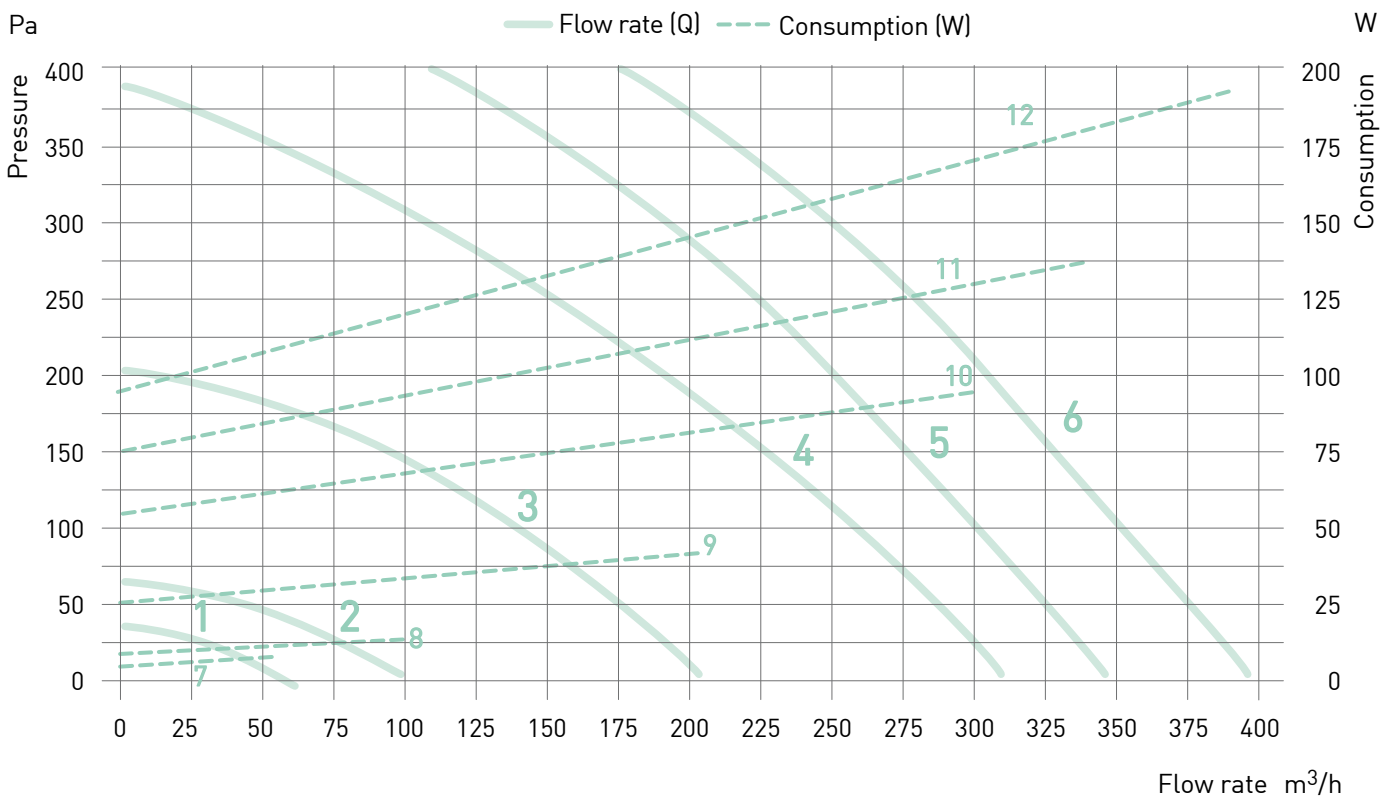

NOISE LEVEL LW(A)

IRRADIATION		Total	63 Hz	125 Hz	250 Hz	500 Hz	1000 Hz	2000 Hz	4000 Hz	8000 Hz
		[dB(A)]	[dB]	[dB]	[dB]	[dB]	[dB]	[dB]	[dB]	[dB]
25 m ³ /h	20 Pa	<23.5	47.2	30.4	23.3	21.4	13.2	11.5	4.7	9.4
75 m ³ /h	20 Pa	30.5	45.2	34.2	32.1	29.6	24.2	18.1	5.6	9.3
150 m ³ /h	80 Pa	46.5	46.6	44.9	46.3	44.8	40.9	39.4	25.1	15.4
225 m ³ /h	100 Pa	53.8	50.0	48.1	52.7	52.2	47.8	47.3	35.7	24.1
225 m ³ /h	150 Pa	55.0	53.6	48.7	53.0	53.8	48.9	48.7	38.6	29.5
275 m ³ /h	100 Pa	57.5	58.2	49.6	56.4	55.7	51.5	50.8	41.3	29.4
275 m ³ /h	150 Pa	58.5	61.8	50.4	56.8	56.7	52.5	51.8	43.4	38.4
325 m ³ /h	100 Pa	60.5	58.6	50.4	58.9	58.1	54.7	53.7	45.6	33.7
325 m ³ /h	150 Pa	61.5	54.7	51.8	59.2	59.3	55.6	54.5	47.2	37.0

PLANT COMPONENTS

INSTALLATION DIAGRAM

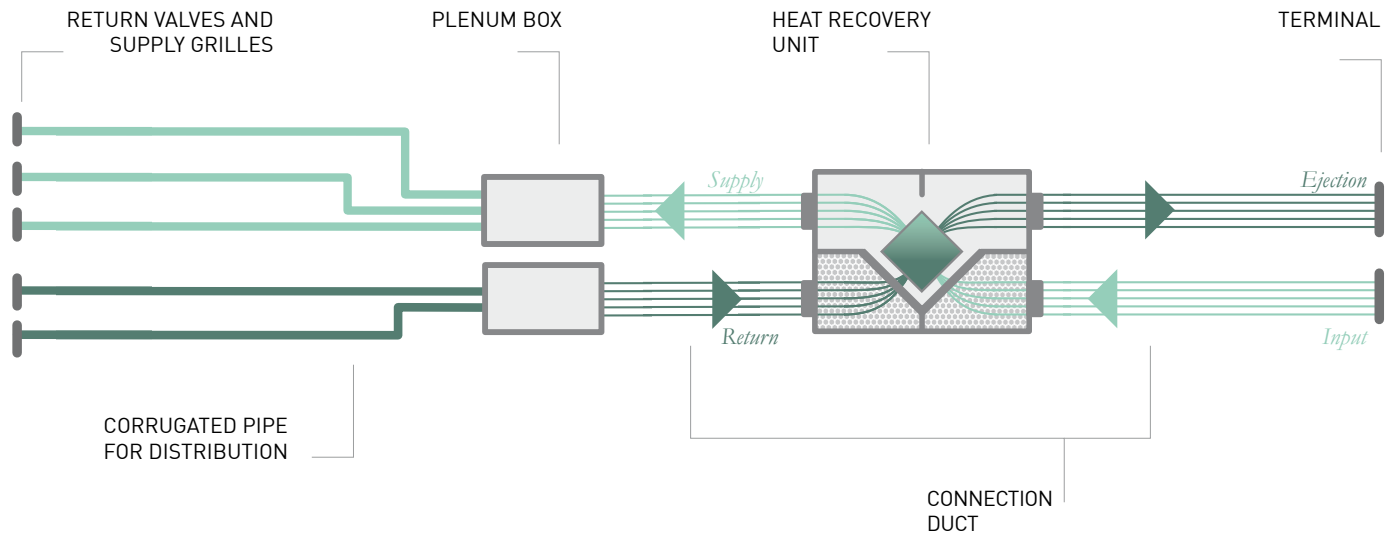

TERMINAL

EXTERNAL AIR INPUT TERMINAL

CODE	MODEL	colour	Ø
AP19900	TPE-150 N	■ BLACK	150 mm
AP19901	TPE-150 B	□ WHITE	150 mm
AP19902	TPE-150 G	■ GREY	150 mm
AP19903	TPE-180 N	■ BLACK	180 mm
AP19904	TPE-180 B	□ WHITE	180 mm
AP19905	TPE-180 G	■ GREY	180 mm



EXTERNAL AIR EJECTION TERMINAL

CODE	MODEL	Length	Ø
AP19906	TT-150	Extension from roof 550 mm	150 mm
AP19907	TT-180	Extension from roof 550 mm	180 mm



CONNECTION DUCT

EPP ANTI-CONDENSATION DUCT

CODE	MODEL	length	∅ int.	∅ ext.
AP19908	CPE-150	Duct 1 metre	150 mm	180 mm
AP19909	CPE-180	Duct 1 metre	180 mm	210 mm

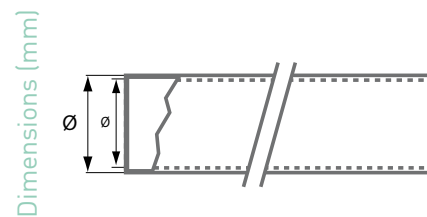

90° EPP CURVE

CODE	MODEL	∅ int.	∅ ext.
AP19910	CV90-150	150 mm	180 mm
AP19911	CV90-180	180 mm	210 mm

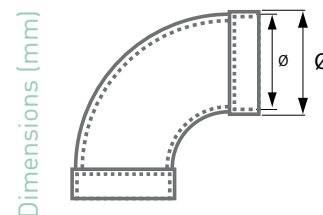

45° EPP CURVE

CODE	MODEL	∅ int.	∅ ext.
AP19912	CV45-150	150 mm	180 mm
AP19913	CV45-180	180 mm	210 mm

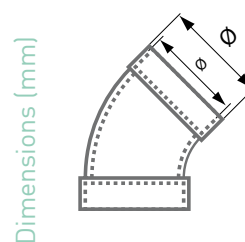

EPP FITTING

CODE	MODEL	∅ int.	∅ ext.
AP19914	RC-150	150 mm	180 mm
AP19915	RC-180	180 mm	210 mm

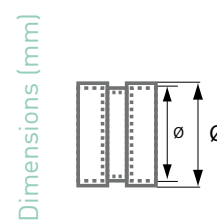

FLEXIBLE ALUMINIUM DUCT

Flexible double wall aluminium duct reinforced with steel wire spiral.

CODE	MODEL	material	length	Ø
AP19710	TFA 102/10	AL	10 m roll	102 mm
AP19711	TFA 127/10	AL	10 m roll	127 mm
AP19712	TFA 152/10	AL	10 m roll	152 mm
AP19713	TFA 160/10	AL	10 m roll	160 mm
AP19714	TFA 204/10	AL	10 m roll	204 mm



FLEXIBLE ALUMINIUM INSULATED DUCT

Flexible aluminium and polyester duct with internal fibreglass insulating layer with 25 mm thickness.

CODE	MODEL	material	length	Ø
AP19715	TFAI 102/10	AL	10 m roll	102 mm
AP19716	TFAI 127/10	AL	10 m roll	127 mm
AP19717	TFAI 152/10	AL	10 m roll	152 mm
AP19718	TFAI 160/10	AL	10 m roll	160 mm
AP19719	TFAI 204/10	AL	10 m roll	204 mm



ADAPTER FOR FLEXIBLE PIPE DN152 - ASPIRCOMFORT

CODE	MODEL	for	material	Ø
AP19751	AD15-15	TFA152/10, TFAI 152/10 and ASPIRCOMFORT	Al ZN	150 mm

PLENUM BOX

INSULATED DISTRIBUTION PLENUM

CODE	MOD.	No. connections	m ³ /h	mm			
				length	width	height	∅
AP19921	PB17-150	17	350	680	200	150	150
AP19922	PB14-150	14	300	560	200	150	150
AP19923	PB11-150	11	225	430	200	150	150
AP19924	PB8-150	8	150	310	200	150	150
AP19920	PB5-125	5	140	215	215	145	125

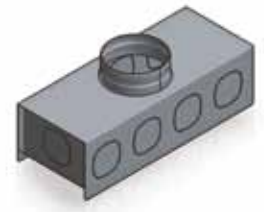

INSPECTABLE DISTRIBUTION PLENUM

CODE	MODEL		No. connections	m ³ /h	mm			
					a	b	c	∅
AP19925	PDS	(for AP19926)	1	350	603	233	207	150 / 180
AP19926	PDI	(for AP19925)	12	350	603	271	207	DN75 / DN90



BOX PLENUM CONNECTION

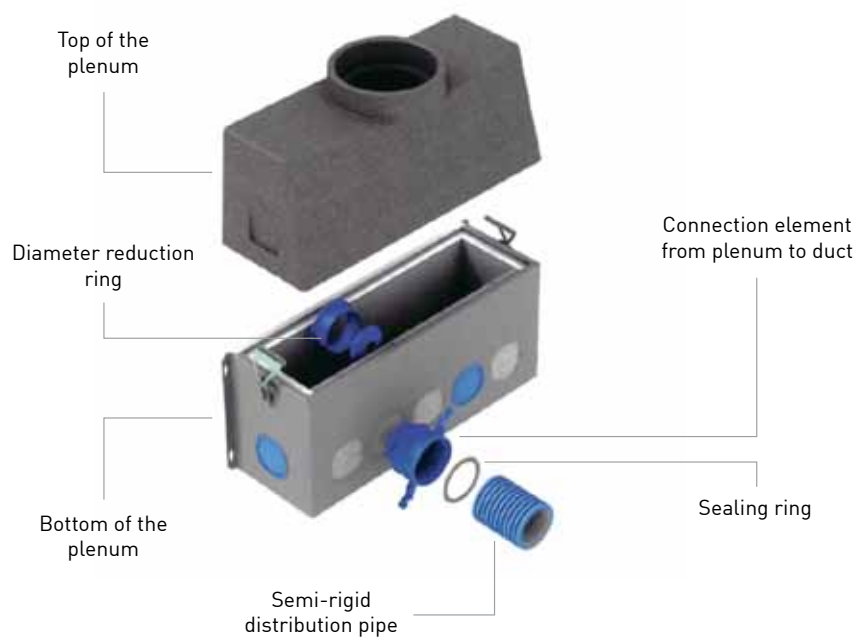

DISTRIBUTION PIPES

CORRUGATED PIPE FOR THE DISTRIBUTION OF THE SUPPLY OR RETURN AIR

CODE	MODEL	colour / type	roll length	Ø internal	DN Ø external
AP19930	TCR-75	■ RED / return	50 m	63 mm	75 mm
AP19931	TCR-90	■ RED / return	50 m	76 mm	90 mm



CORRUGATED PIPE FOR THE DISTRIBUTION OF THE SUPPLY OR RETURN AIR

Made of self-extinguishing HDPE, with UV treatment and internal anti-static treatment

CODE	MODEL	colour / type	roll length	Ø internal	DN Ø external
AP19994	TCRM-75	■ BLUE	50 m	63 mm	75 mm
AP19995	TCRM-90	■ BLUE	50 m	76 mm	90 mm



90° FITTING BETWEEN TWO CORRUGATED PIPES AND THE RETURN VALVE

CODE	MODEL		DN
AP19936	RA2V-75	90° fitting between two corrugated pipes DN75 and the return valve	75 mm



90° FITTING BETWEEN CORRUGATED PIPE AND THE RETURN VALVE

CODE	MOD.		DN
AP19937	RA1V-90	90° fitting between corrugated pipe DN90 and the return valve	90 mm



STRAIGHT FITTING BETWEEN TWO CORRUGATED PIPES AND THE RETURN VALVE

CODE	MOD.		DN
AP19938	RR2V-75	Straight fitting between two corrugated pipes DN75 and the return valve	75 mm



STRAIGHT FITTING BETWEEN CORRUGATED PIPE AND THE RETURN VALVE

CODE	MOD.		DN
AP19939	RR1V-90	Straight fitting between corrugated pipe DN90 and distribution/return terminal	90 mm



FITTING FOR CORRUGATED PIPE

CODE	MODEL		DN
AP19932	RTC-75	Fitting for corrugated pipe DN75 with sealing rings.	75 mm
AP19933	RTC-90	Fitting for corrugated pipe DN90 with sealing rings.	90 mm



FITTING BETWEEN CORRUGATED PIPE AND PLENUM

CODE	MODEL		DN
AP19934	RTP-75	Fitting between corrugated pipe DN75 and plenum with sealing rings	75 mm
AP19935	RTP-90	Fitting between corrugated pipe DN90 and plenum with sealing rings	90 mm



BRACKET TO ANCHOR CORRUGATED PIPE

CODE	MOD.		No. of pieces pack	DN
AP19940	STC-75	Bracket to anchor corrugated pipe DN75	10	75 mm
AP19941	STC-90	Bracket to anchor corrugated pipe DN90	10	90 mm



DUST CAP

CODE	MOD.		No. of pieces pack	DN
AP19942	TP-75	Dust cap for corrugated pipe DN75 and ducts	10	75 mm
AP19943	TP-90	Dust cap for corrugated pipe DN90 and ducts	10	90 mm



CONTROL DIAPHRAGM

CODE	MOD.		No. of pieces pack
AP19944	DFR	Flow rate control diaphragm	1



AIR RETURN AND SUPPLY

CONE-SHAPED RETURN VALVE

CODE	MOD.	m ³ /hreturn	Ø
AP19945	VDC-1	50 ÷ 75 adjustable	115 mm



CONE-SHAPED RETURN VALVE

CODE	MOD.	m ³ /h	mm	
			ØA	ØC
AP19780	VVA-100	35 ÷ 120	148	99
AP19781	VVA-125	40 ÷ 170	168	124
AP19782	VVA-160	60 ÷ 220	186	149/159
AP19783	VVA-200	70 ÷ 330	240	198

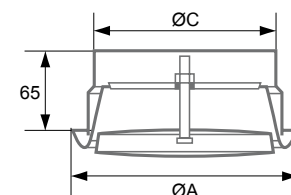

STEEL SUPPLY GRILLE

CODE	MOD.	mm		holes	colour	m ³ /h
		width	height			
AP19947	GDA-70G	260	155	slot	■ SILVER	70
AP19948	GDR-70G			round	■ SILVER	70
AP19949	GDQ-70G			square	■ SILVER	70
AP19950	GDA-70B			slot	□ WHITE	70
AP19951	GDR-70B			round	□ WHITE	70
AP19952	GDQ-70B			square	□ WHITE	70



PLENUM FOR SUPPLY GRILLE

Insulated galvanised sheet metal plenum for rectangular grilles.

CODE	MOD.	mm		
		depth	width	height
AP19953	PGR	140	232	127



CODE	MOD.	description	mm		
			depth	width	height
AP19963	PGR 90L	with side fitting DN90	100	232	127
AP19964	PGR 75L	with side fitting DN75	85	232	127
AP19965	PGR 90H	with top fitting DN90	100	232	127
AP19966	PGR 75H	with top fitting DN75	85	232	127

