

CH130ARR-CH130ARFR

Room thermostats for fan-coils, 3 speeds + automatic

CH130A model is a fan-coil 4- or 2-pipe thermostat that allows you to control the ambient temperature both in the heating and cooling modes. Is able to drive one or two valves and also control a 3-speed fan-coil motor, either in manual or automatic mode.

CH130ARR has a separately activation unit with two-wire connection, while the CH130ARFR model has the separately activation unit with which communicates via radio frequency (wireless).

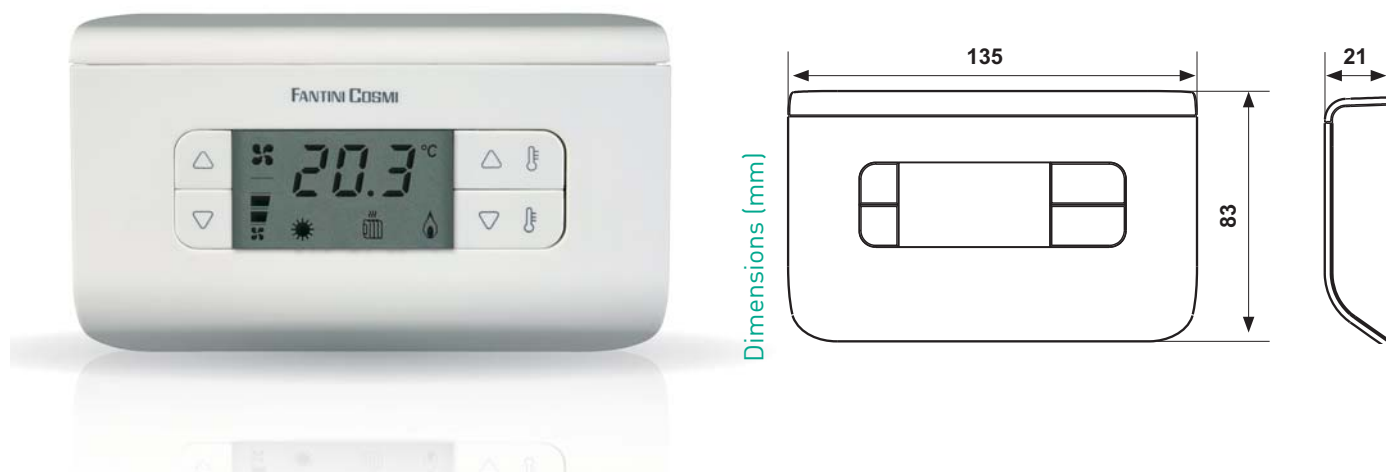

KIT COMPOSITION TABLE

KIT CODE	THERMOSTAT CODE	ACTUATOR CODE	FAN SPEED	CONNECTION TYPE
CH130ARR	CH130AR	CH172D	manual + auto	2 wires
CH130ARFR	CH130ARF	CH172DRF	manual + auto	wireless

CH130ARR

KIT WITH REMOTE RELAY MADE UP OF: CH130AR THERMOSTAT + CH172D ACTUATOR



	Mounting	Temperature regulation range	Body admissible temperature	Power supply	N° relay	Power supply	Protection degree
CH130AR	wall mounting	2 ÷ 40 °C	45 °C	actuator CH172D	-	-	IP20
CH172D	6-module DIN rail		45 °C	230V-50Hz	5	5(3)A 250Vac	IP00
CH172DS*	6-module DIN rail		45 °C	230V-50Hz	5	5(3)A 250Vac	IP00

*CH172DS is used to control more fan-coils.

CH130ARFR

RADIO FREQUENCY KIT MADE UP OF: CH130ARF THERMOSTAT + CH172DRF ACTUATOR



	Mounting	Temperature regulation range	Body admissible temperature	Power supply	N° relay	Power supply	Protection degree
CH130ARF	wall mounting	2 ÷ 40 °C	45 °C	2 batteries AA 1,5V	-	-	IP20
CH172DRF*	6-module DIN rail		45 °C	230V-50Hz	5	5(3)A 250Vac	IP00

*To control more fan-coils, always use CH172DRF actuator.

CH130ARR ELECTRICAL FEATURES

Power supply from a remote actuator.
Remote actuator with 5 output relays, voltage 250 Vac.
Contacts rating 5(3)A.

4-TUBE INSTALLATION

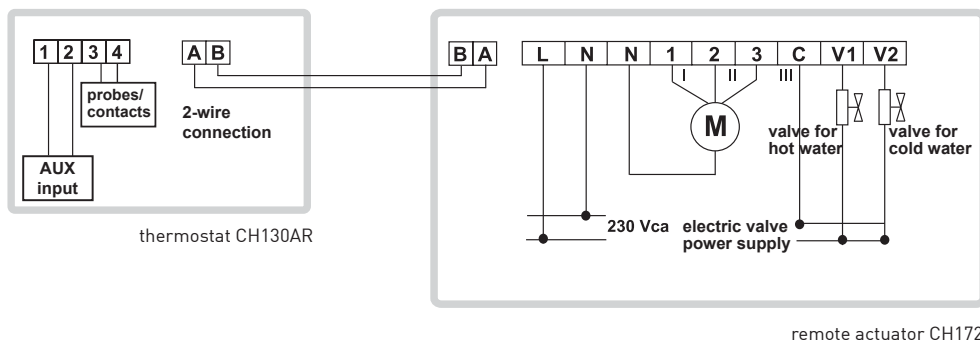

2-TUBE INSTALLATION

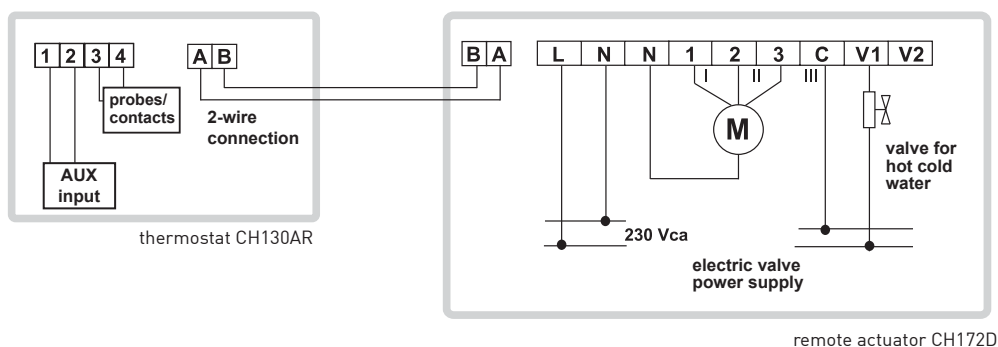

AUX INPUT CONFIGURATION

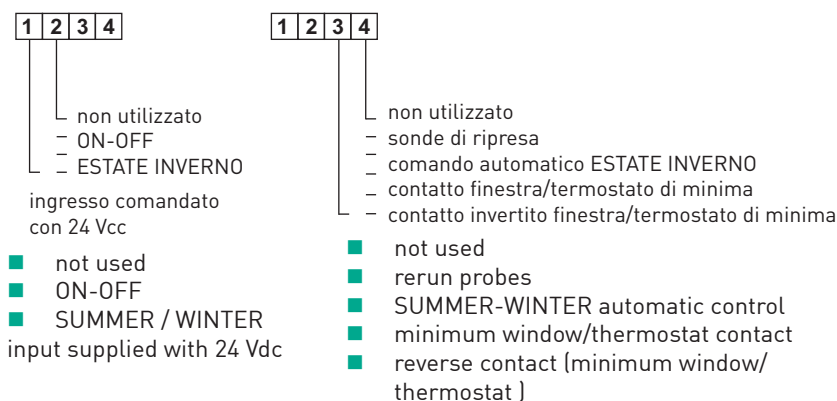

CH130ARFR ELECTRICAL FEATURES

Power supply from 2 AA type batteries of 1,5V.
Remote actuator with 5 output relays, voltage 250 Vac.
Contacts rating 5(3)A.

4-TUBE INSTALLATION

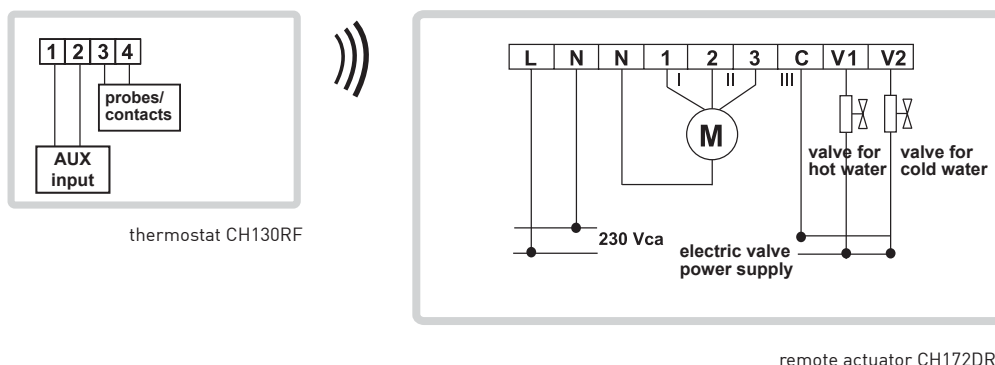

2-TUBE INSTALLATION

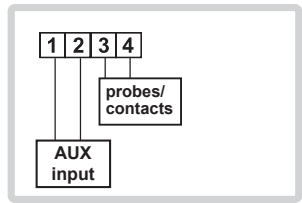

thermostat CH130RF

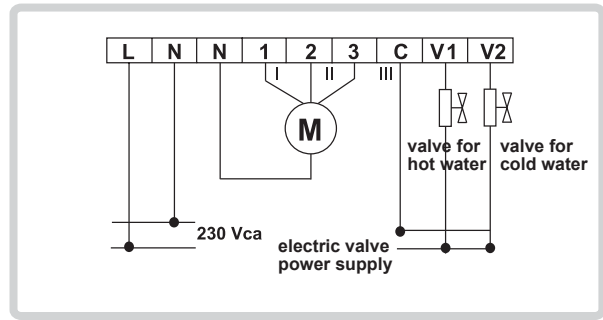

remote actuator CH172DRF

AUX INPUT CONFIGURATION

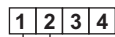

- non utilizzato
- ON-OFF
- ESTATE INVERNO

ingresso comandato con 24 Vcc

- not used
- ON-OFF
- SUMMER / WINTER input supplied with 24 Vdc

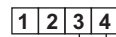

- non utilizzato
- sonde di ripresa
- comando automatico ESTATE INVERNO
- contatto finestra/termostato di minima
- contatto invertito finestra/termostato di minima

- not used
- rerun probes
- SUMMER-WINTER automatic control
- minimum window/thermostat contact
- reverse contact (minimum window/thermostat)

HOMOLOGATION AND STANDARDS

Complies with EN 60730-2-9 standards

ErP: ErP Class IV; 2% (Reg. EU 811/2013 -813/2013)



INSTALLATION

The thermostat is supplied complete with a base suitable for mounting on the wall, as well in rectangular or round built-in 3-seat boxes.

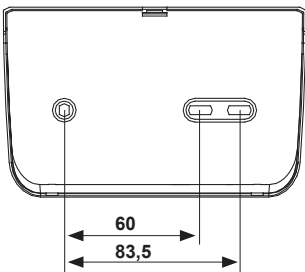

MOUNTING HOLES, mm

OPERATION

CH130ARR is supplied from the actuator and is able to drive two valves and also control a 3-speed fan-coil motor.

CH130ARFR is supplied with two AA batteries of 1,5V and is able to drive two valves and also control a 3-speed fan-coil motor by means of CH172DRF actuator.

The wide display shows the measured temperature, fan speed, the running program and the selected season.

The settings and data are stored in a permanent (nonvolatile) memory capable of keeping them even in the absence of power supply or when the batteries are not inserted (according to the model).

SUMMER/WINTER SELECTION

To switch from the "Winter" operation (i.e. heating system) to the "Summer" operation (i.e. cooling system), and vice versa, press the 1+2 button combination. The selected operation mode will be indicated on the display by the "Winter" or "Summer" icons.

BUTTONS COMBINATIONS

- 1 fan speed increase button, at the maximum prescribed speed is configured the "AUTO" operating mode.
- 2 fan speed decrease button, exits the "AUTO" mode and decreases the fan speed.
- 1+2 SUMMER/WINTER switch.
- 3 temperature value increase button for the selected program.
- 2+4 Celsius/Fahrenheit switch.
- 3+4 COMFORT/ECONOMY switch.
- 4 temperature value decrease button for the selected program.
- 5 thermostat reset button.

VISUALIZATION (SIGNALS)

- measured temperature
- COMFORT symbol
- ECONOMY symbol
- SUMMER symbol
- WINTER symbol
- fan speed symbol

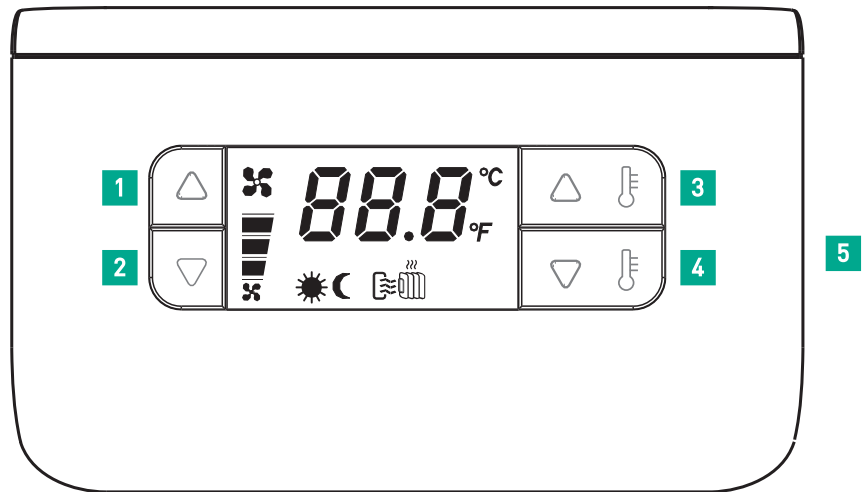

OPERATING MODES

CH130... thermostats have 3 different operating modes:

- With the COMFORT operating mode, the thermostat regulates the heating or cooling installation operation in order to always keep the same prescribed comfort temperature.
- With the ECONOMY operating mode, the thermostat regulates the heating or cooling installation operation in order to always keep the same prescribed economy temperature.
- [OFF] function can be achieved by setting the fan speed to zero. In this case, the thermostat does not perform the regulation. The system will switch OFF completely and on display will appear the message "OFF".

FAN SPEED SELECTION

- MANUAL: fan speed can be set manually to free fixed levels (minimum, medium, maximum).
- AUTO: if the speed is set in Auto, the thermostat sets automatically the appropriate speed according to the difference between the set-point and the ambient temperature.
- CH130A thermostat has available a TECHNICAL MENU for adapting to different system types.

TECHNICAL MENU

SYSTEM TYPE

- 2-tube system: the thermostat will drive only the valve (ON/OFF type) used for heating both during the heating and the cooling; in fact, the valve will control both hot water and cold water.
- 4-tube system: the thermostat will drive one valve (ON/OFF type) used for heating, plus one additional valve (ON/OFF type) used for cooling, based on the needs of the environment.

EXTERNAL PROBE

- **RESUMPTION:** instead of the probe incorporated into the thermostat, an external probe can be used to read the ambient temperature and carry out heat regulation. Typically, this probe will be positioned under the fan-coil where air is sucked.
- **CHANGEOVER:** the external temperature probe can be placed on the fan-coil delivery tube of a 2-tube system to perform automatic changeover between the "Summer" operation and the "Winter" operation.
- **MINIMUM WINDOW/THERMOSTAT CONTACT:** when the contact is open, the thermostat will carry out heat regulation; when it is closed, the heat regulation will not be carried out.
- **INVERTED MINIMUM WINDOW/THERMOSTAT CONTACT:** the window contact will operate with an inverted logic with respect to the statements made in previous step 3.
- **NONE:** the external probe input will not be controlled by the thermostat.

DISPLAY VISUALIZATION

- **AMBIENT TEMPERATURE:** the ambient temperature will be shown on the display.
- **SET-POINT:** the current set point will be shown on the display.

CENTRAL INPUT CONFIGURATION

- **ON/OFF:** in the event that several thermostats have been installed, you may decide either to drive all of them in the normal operation condition (ON) or taking advantage of the OFF function by controlling them through a central point. The thermostat will be configured to OFF when the input is powered with 24 V (d.c. with no polarity obligation or a.c.); on the contrary, it will remain active when the input is free from voltage.
- **SUMMER/WINTER:** as in the previous case, the thermostat will be configured to "Summer" mode when the input is powered with 24 V; on the contrary, it will remain active in the "Winter" mode when the input is free from voltage.
- **NONE:** the thermostat will not carry out any operation, whatever the input status.

SUMMER VALVE TYPE

- **NORMALLY OPEN:** in this case, the water flow is normally open and will be closed when the valve is supplied.
- **NORMALLY CLOSED:** when the valve is energized, it will open the water flow.

WINTER VALVE TYPE

- **NORMALLY OPEN:** in this case, the water flow is normally open and will be closed when the valve is supplied.
- **NORMALLY CLOSED:** when the valve is energized, it will open the water flow.

AMBIENT TEMPERATURE CORRECTION

- It can be adjusted from -4.0 to 4.0°C . This parameter is used to correct the acquired ambient temperature. In fact, in some installations, the ambient temperature reading may not be satisfying, due to the probe location (i.e. internal or resumption). With this parameter, a constant value upon reading can be added to or subtracted from.

"WINTER" LOWER LIMIT SET-POINT TEMPERATURE

- It can be adjusted from 2.0 to 40.0°C . It represents the lower limit for all the set-points (Comfort and Economy) in the heating mode.

"WINTER" UPPER LIMIT SET-POINT TEMPERATURE

- It can be adjusted from 2.0 to 40.0°C . It represents the upper limit for all the set-points (Comfort and Economy) in the heating mode.

"SUMMER" LOWER LIMIT SET-POINT TEMPERATURE

- It can be adjusted from 2.0 to 40.0°C . It represents the lower limit for all the set-points (Comfort and Economy) in the cooling mode.

"SUMMER" UPPER LIMIT SET-POINT TEMPERATURE

- It can be adjusted from 2.0 to 40.0°C . It represents the upper limit for all the set-points (Comfort and Economy) in the cooling mode.

CHANGEOVER LOWER THRESHOLD

- It can be adjusted from 0 to 24°C . It defines the changeover function lower threshold. Below this temperature, the thermostat will be set to the cooling mode.

CHANGEOVER UPPER THRESHOLD

- It can be adjusted from 26 to 48°C . It defines the changeover function upper threshold. Above this temperature, the thermostat will be set to the heating mode.

A CH130ARR can control up to 5 fan-coil units simultaneously, using only two cables for connecting to the actuators. One of these actuators must be a CH172D, while others, maximum four, will be CH172DS. A CH130ARFR can control an unlimited number of actuators provided that they are located within reception range of 30 meters.

CONNECTION EXAMPLE BETWEEN CH130AR+CH172D AND 1 FAN-COIL

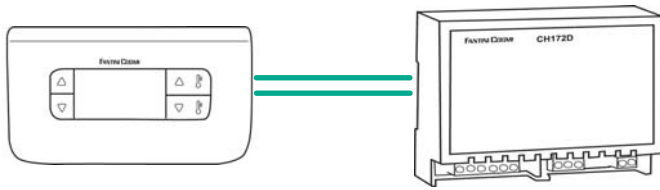

CONNECTION EXAMPLE BETWEEN CH130AR+CH172D+CH172DS AND FEW FAN-COILS (FROM 2 TO 5)

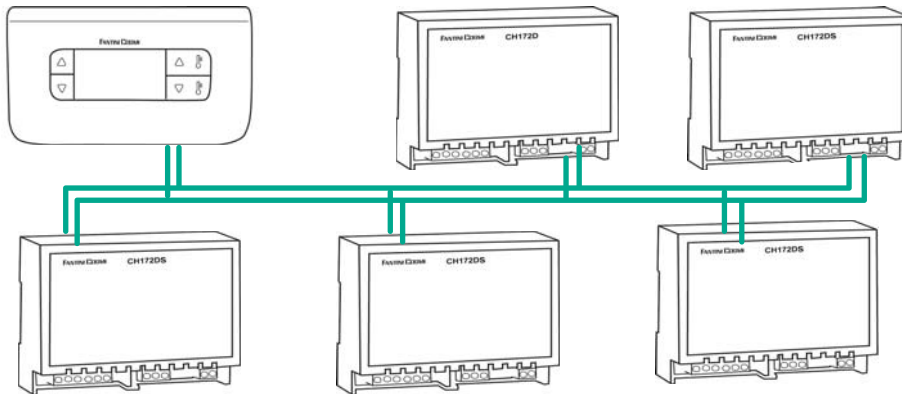

CONNECTION EXAMPLE BETWEEN CH130ARFR+CH172DRF AND 4 FAN-COILS

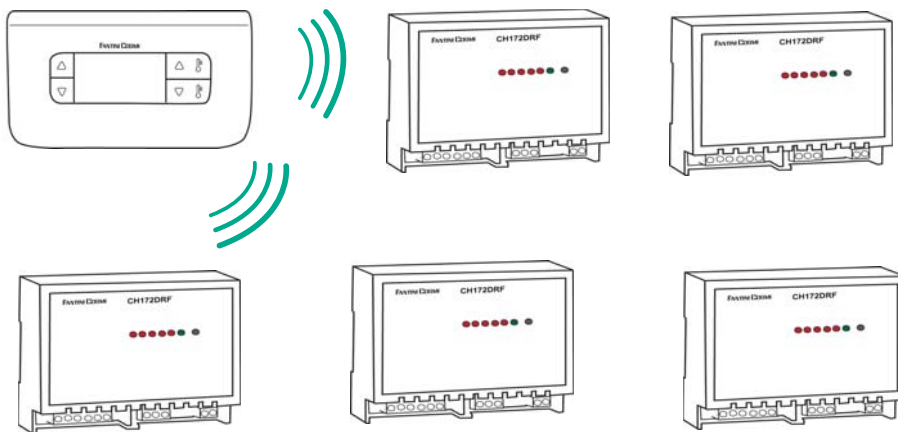

FEATURES

- Auxiliary input for minimum window and/or thermostat contact using an external probe.
- Screwed terminals.
- double insulation.
- Dimensions 135 X 83 X 21 mm.