

ECVCONB DATALOGGER M-BUS

1. OVERVIEW

- Datalogger with webservice interface
- Manages up to 500 meters of which a max of 250 wired
- Manages up to 23 ECVRRB repeaters
- Archived data over the last 10 years
- Wired meters data acquisition interval from 15' to 1 month
- Wireless meters data acquisition through ECVRRB repeater
- Meters reading, report sending, system remote management
- 24Vdc +/- 10%, 24Vac (min 20Vac, max 40Vac) power Supply or PoE
- DIN rail mounting (4 modules)
- Graphic display and digital I/O

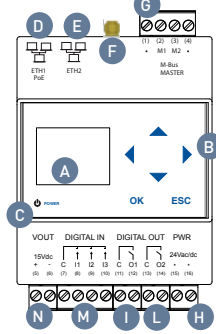

- A. Graphic display
- B. Navigation keys
- C. Led power supply
- D. Ethernet Port 1 (PoE)
- E. Ethernet Port 2
- F. SMA antenna connector
- G. M-Bus connector (max 20 meters)
- H. Power supply connector
- I. Relay 1 connector
- L. Relay 2 connector
- M. Digital input connector
- N. Auxiliary output voltage connector

2. CONNECTIONS

DIGITAL INPUTS:

- (7) - Common for digital inputs
- (8) - Digital input 1 (Vin 12-24Vdc)
- (9) - Digital input 2 (Vin12-24Vdc)
- (10) - Digital input 3 (Vin12-24Vdc)

RELAY OUTPUT:

- (11) - Common Relay 1
- (12) - NO Relay 1 Contact
- (13) - Common Relay 2
- (14) - NO Relay 2 Contact

CONNECTION TO THE FIELDBUS

- (1) - Not connected
- (2) - Pole 1 for connection to M-BUS meters
- (3) - Pole 2 for connection to M-BUS meters
- (4) - Not connected

POWER SUPPLY:

- (15) - Input 1 for power supply
- (16) - Input 2 for power supply
- (ETH2) - Ethernet Port for LAN connection.
- (ETH1) - Ethernet Port for LAN connection (PoE)

AUXILIARY OUTPUT VOLTAGE:

- (5) - Vout positive pole +15V, I_{max} = 10mA
- (6) - Vout negative pole

DIRECT CONNECTION TO M-BUS DEVICES

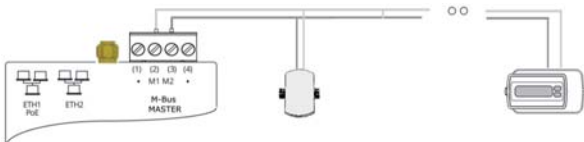

LAN CONNECTION

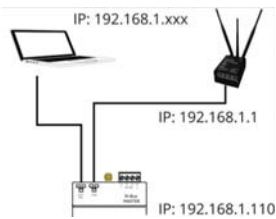

CONNECTION TO M-BUS REPEATER ECC60MBUS

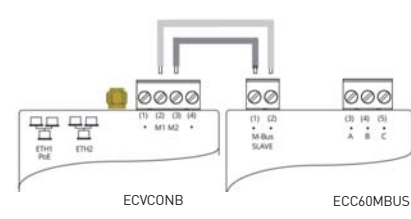

ATTENTION! In order to avoid damaging the device, apply a voltage equal to 24Vdc +/- 10%, 24 Vac (min 20 Vac, max 40 Vac) power supply to the terminals (15) and (16). Before making any connections, turn off the power, remove the terminals, complete the wiring and the plug terminals with the correct position.

FREE VOLTAGE INPUT CONNECTION

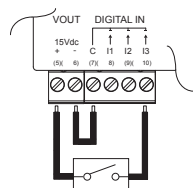

RELAY OUTPUT CONNECTION

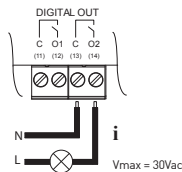

NEGATIVE VOLTAGE INPUT CONNECTION

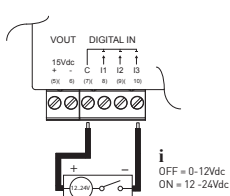

POSITIVE VOLTAGE INPUT CONNECTION

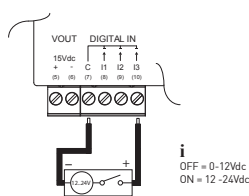

3. FIRST SETUP VIA DISPLAY

On first use of the device:

1. Connect the M-Bus devices to ECVCONB to terminals M1(2) and M2 (3) as indicated in the manufacturer's guide
2. Enter the default password 000000 to access the menu.
3. Press OK at the menu "Search" and follow the instructions given below.

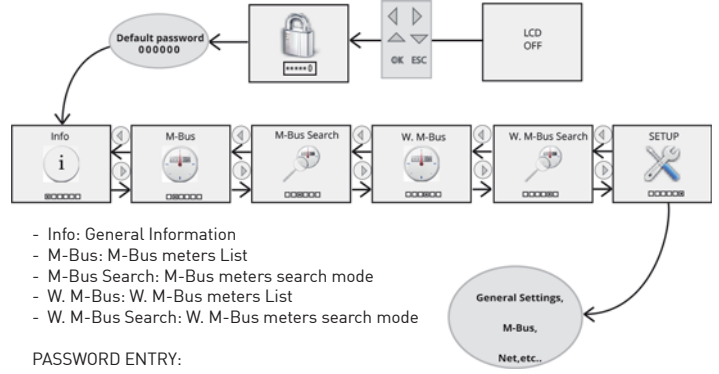

- Info: General Information
- M-Bus: M-Bus meters List
- M-Bus Search: M-Bus meters search mode
- W. M-Bus: W. M-Bus meters List
- W. M-Bus Search: W. M-Bus meters search mode

PASSWORD ENTRY:

The blinking cursor indicates which of the six-digit of the password you are entering:

- Use \blacktriangle key to increase the current number
- Use \blacktriangledown key to decrease the current number
- Use **OK** key to confirm the current value and move to the next or confirm
- Use \blacktriangleleft \blacktriangleright keys to change the language

4. FIRST ACCESS TO THE WEBSERVER

1. Connect one of the two Ethernet ports to your PC
2. Make sure that your PC has an IP address of 192.168.1.xxx type where xxx is a number between 1 and 254 and different from 110
3. Open an internet browser (Chrome, Firefox or Safari)
4. On the address bar type 192.168.1.110
5. At authentication request enter the default credentials (User Name: Admin Password: Admin)
6. Click on the upper right "help" icon to display the user manual and follow the instructions given for the use of web part

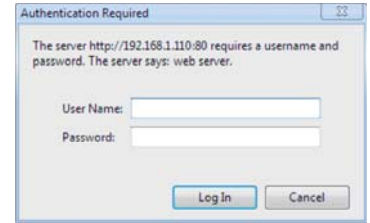

5. TECHNICAL DATA

- Temperature range: operative: -20° ... +55°C. storage: -25° ... +65°C.
- Protection degree: IP 20 (EN60529).
- Mounting: 35mm DIN Rail (EN60715)
- Dimensions: 4 DIN modules (90x72x64.5).
- Power supply: 24Vdc +/- 10%, 24Vac (min 20Vac, max 40 Vac) or PoE
- Consumption: 7.5W
- Max load relays: 5A@30Vdc (Resistive Load) 2A@30Vdc (Inductive Load cosφ=0.4 ; L/R=7ms)

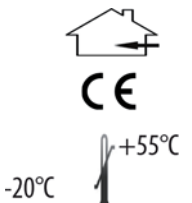

6. TROUBLESHOOTING

THE DATALOGGER DOES NOT TURN ON:

- Check with the aid of a multimeter that the voltage between the terminals (15) and (16) is 24Vdc +/- 10%, 24Vac (min 20Vac, max 40 Vac)
- In case of power supply from the LAN (Power Over Ethernet) verify that the LAN cable is connected to the PoE switch

THE DISPLAY IS OFF:

- After 10 minutes of inactivity, the display turns off. To turn it on again, press any key.

NOT ALL THE METERS ARE DETECTED:

- Verify that not detected meters support 2400 bps default communication speed and addressing for primary and secondary address
- Verify that the maximum number of allowed wired meters hasn't been already configured
- Make sure that the antenna position provides a good radio signal for all devices
- Check that the maximum number of allowed radio meters hasn't been already configured

NONE OF THE METERS IS DETECTED:

- Check that the meters are correctly connected to the terminals (2) and (3) of the ECVCONB
- Check with a multimeter the connection between ECVCONB and the devices
- Check for short circuit on M-Bus wiring
- Make sure that the antenna is enclosed in a shielded location
- Check that the meters that were not revealed are not too distant from ECVRRB or that the signal is not disturbed by thick concrete or metal walls
- Check that the devices are on the list loaded in ECVRRB or that the W. M-Bus devices list receivable from ECVRRB is not blocked
- Attenzione: alcuni dispositivi WMBUS trasmettono con periodicità anche di diverse ore
- Check that the MESH network is not interrupted using ECVCONB web interface.

UNABLE TO ACCESS THE WEBSERVER:

- Verify that your PC has an address in the same network as the datalogger. The datalogger default IP address is 192.168.1.110, then the PC must have a 192.168.1.xxx address different from 192.168.1.110
- Verify that there is no firewall blocking the port TCP / IP 80

6. WIRED AND WIRELESS METERS CONNECTION

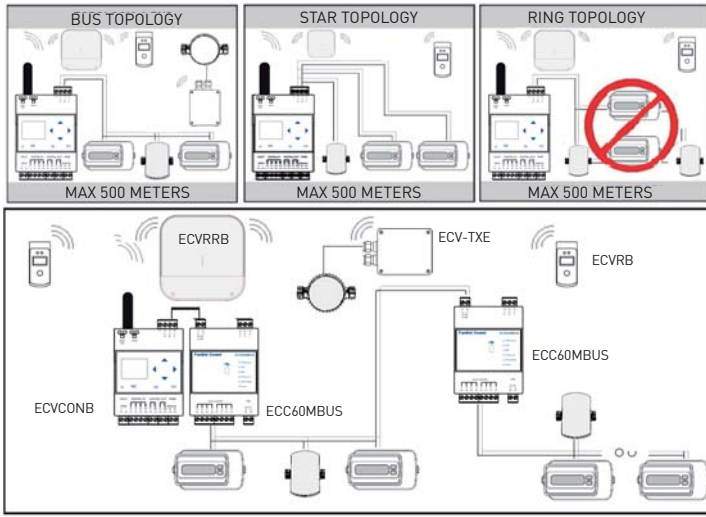

7. M-BUS SETUP

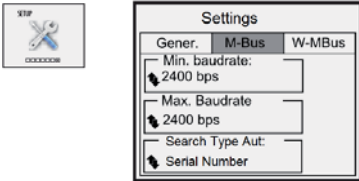

- Min. Baudrate: Minimum baudrate value for the detection of devices on wired M-Bus network
- Max. Baudrate: Maximum baudrate value for the detection of devices on wired M-Bus network
- Search Type Aut: Search by serial number or Primary Address EN13757-3 (Application Layer)

The M-Bus interface complies with EN13757-2 (Physical Layer)

8. M-BUS SEARCH PROCESS

1. start the search
2. check the progress of the search
3. control the detected M-Bus devices
4. select a device
5. reading of the current values of the meters

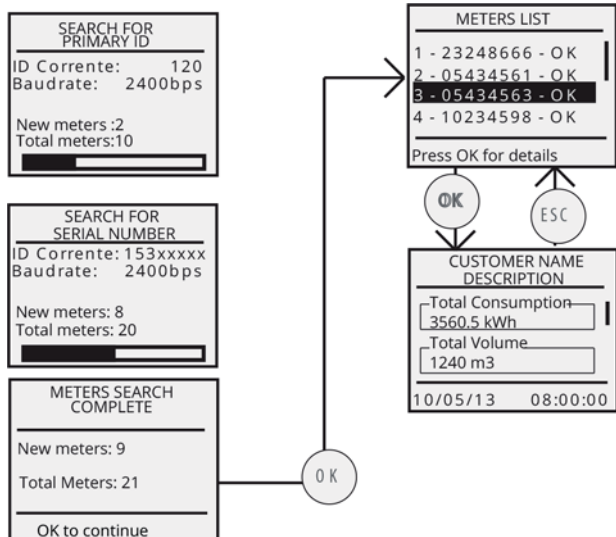

Wait until the process is complete

9. ANTENNA INSTALLATION

FEATURES

Dimensions: 100x80x30 mm
 Connection: SMA Male
 Cable: RG174 1.5 m
 Operating Temperature range: -40°/+80° C
 Polarization: Linear
 Radiation: Omnidirectional
 Gain: 2.1 dBi
 Antenna constituents: thermoplastic Elastomer
 Material of radiating element: stainless steel, brass
 Antenna stand: stainless steel

ATTENTION

For a correct installation of the product, mount the antenna in vertical position and at 5 cm away from any metallic surface, which it is not closed in a metal box. Please always use the removable antenna provided.

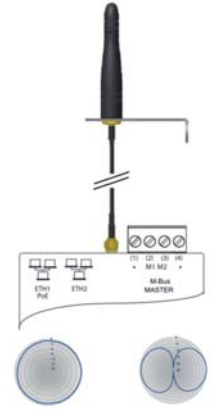

9. W. M-BUS CONFIGURATION

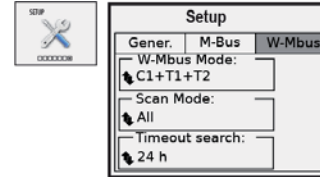

- | | | |
|-----------------|---|---|
| W. M-Bus Mode: | select the transmission mode EN13757-3:2004 and layer dedicated ETSI EN 300 220 v2.3.1 | C1 + T1 +T2
S1 + T1
T1 + T2
T1 |
| Scan Mode | select ALL if you want to acquire all of the present devices. Select SND_IR to acquire only the devices that send the package Installation_Request. | All
SND_IR |
| Timeout search: | defines the timeout for devices search in a range from a minimum of 1 hour to a maximum of 24h | 1-24h |

11. W. M-BUS SEARCH PROCESS

1. start the search
2. check the progress of the search
3. control the detected W. M-Bus devices
4. select a device
5. reading of the current values of the meters

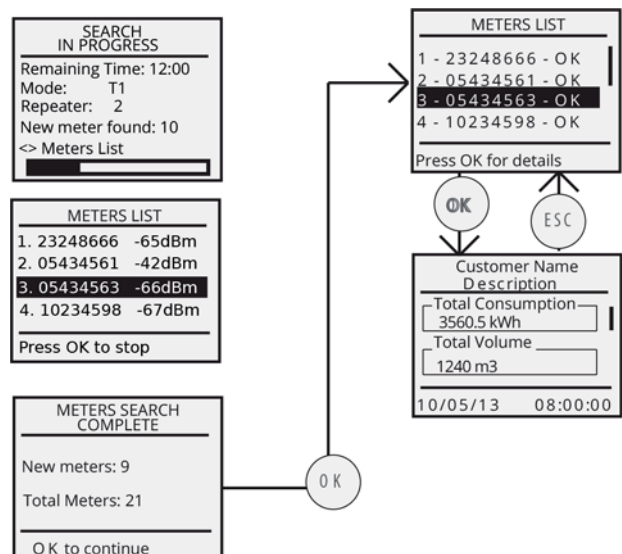

Wait until the value Time Remaining is "0:00"

FANTINI COSMI S.p.A.
 Via dell'Osio, 6 20090 Caleppio di Settala, Milano, ITALY
 Ph. +39 02 956821 - Fax +39 02 95307006 - info@fantinicosmi.it

EXPORT DEPARTMENT
 Ph. +39 02 95682229 - export@fantinicosmi.it

