

Intellitherm C68

Daily programmable thermostat, with batteries

Electronic programmable thermostat with daily programming, to control heating and air-conditioning installations.



Dimensions (mm)

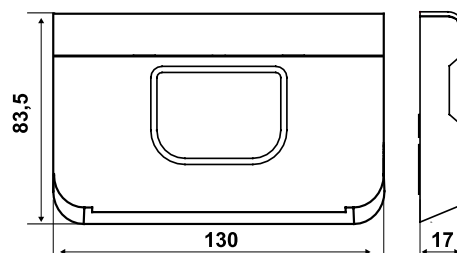

	Comfort regulation range	Economy regulation range	Differential*	Preset antifreeze	Body admissible ambient temperature	Power supply	Contacts rating
C68	16 ÷ 34 °C	5 ÷ 23 °C	0,25 K	5 °C	45 °C	2 batteries AA	5(3)A-250Vac

ELECTRICAL FEATURES

Contacts rating: 5(3)A 250Vac.

Type of action: 1BU (micro disconnection)

Voltage-free switching contact.

Power supply with two 1,5 V AA alkaline long life batteries without connection to the electric circuit.

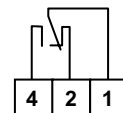

HOMOLOGATION AND STANDARDS

Complies with EN 60730-1, EN 60730-2-9 standards.

ErP classification: ErP Class IV; 2% [EU Reg. 811/2013 - 813/2013]



INSTALLATION

Intellitherm C68 is supplied with a base suitable for installation in embedded 3-module boxes, round boxes or for wall mounting. Equipment lug is minimal and the setting is even easier.

Two-wire connection with the user.

Install the programmable thermostat at 1,5 meters above the floor, away from kitchens, heat sources, windows and doors.

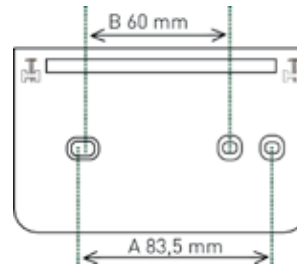

To separate the front body from the mounting socket, remove the battery compartment cover, unscrew the screws from the top, and remove unit's body.

A for 503-type embedded box (3 modules)
B for round embedded boxes

OPERATION

The programmable thermostat has:

- 2 colored knobs, a red one and another blue for COMFORT and ECONOMY temperatures adjustment.
- 1 cursor for choosing the operation mode: AUTO, COMFORT, ECONOMY, ANTIFREEZE.
- 1 cursor for choosing operation type: SUMMER or WINTER, with the same cursor is possible to access the programming.
- 2 keys for current time setting.
- 3 keys to select between COMFORT, ECONOMY and ANTIFREEZE periods.
- 1 RESET button to reset the prescribed program.
- 1 dip switch to select ANTIFREEZE mode at 5°C or OFF (ON at 0°C).



VISUALIZATION

- Ambient temperature
- Current time
- Current day
- Circular crown that represents a 24-hour format clock, is divided in 48 sectors (red, black, red and black): red color indicates COMFORT period; black indicates ANTIFREEZE period; red-black indicates the ECONOMY period.
- Possibility to visualize the statistical data of the installation: operation hours of the previous day and functioning beginning of Intellitherm C68, previous day minimum and maximum temperature and time when it was measured.

OFF SELECTION OR OFF WITH FROST PROTECTION SELECTION

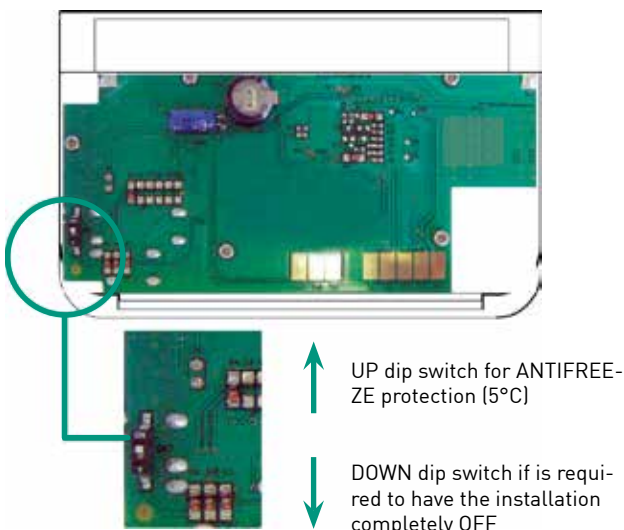

OPERATION HOURS OF THE INSTALLATION

With Intellitherm C68 is possible to know for how many hours was "heat request"(relay closed-ON), the previous day and functioning beginning of the programmable thermostat (ie, after inserting the batteries or from a reset).

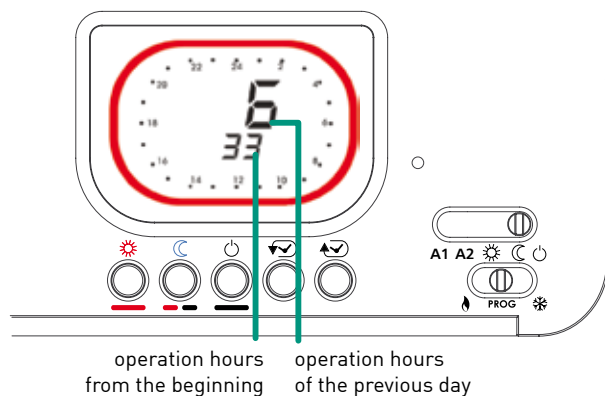



OPERATION MODES

Two preset programs:

- AUTO 1 and AUTO 2 differentiated

- 3 operation modes:

-  COMFORT keeps constant throughout the day and night the prescribed comfort temperature.
-  ECONOMY keeps constant throughout the day and night the prescribed economy temperature.
-  ANTIFREEZE keeps the ambient temperature fixed in 5°C to protect the system from frost danger (or OFF, if it has been selected through the dip switch to have the system completely OFF).

- Personalized programming without intervention limits, even every half hour.
- Three temperatures, programmable as COMFORT and ECONOMY, and fixed as ANTIFREEZE (preset at 5°C).
- JOLLY function to exclude temporarily the automatic program, without modification, for obtaining continuously from 1 to 240 hours always the desired temperature (comfort, economy, OFF). After the preset time has passed Intellitherm resumes the automatically program. To reduce or exclude JOLLY period before the scheduled time expiry press a different color button than the one of the crown shown on the display.

STANDARD AUTOMATIC PROGRAMS WITH THE TIME AND TEMPERATURE ALREADY PROGRAMMED IN THE FACTORY

AUTO 1

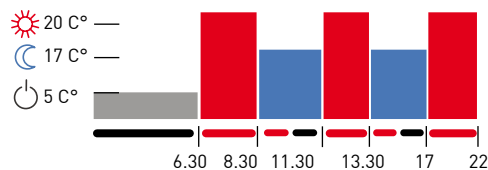

AUTO 2

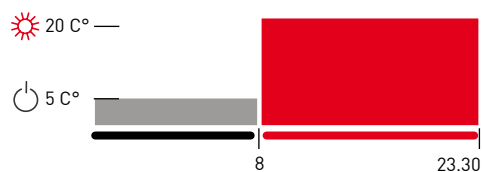

JOLLY FUNCTION

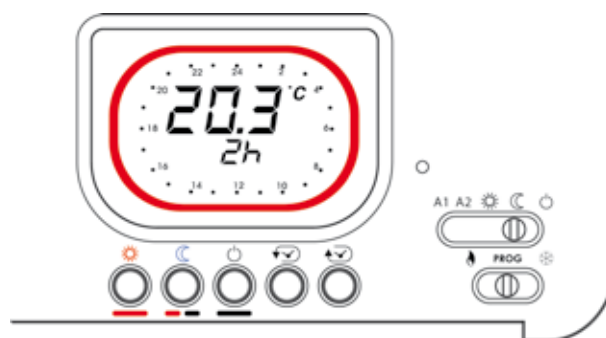

FEATURES

- Front cover for batteries extraction.
- Display flashing in case of low batteries charge.
- Maintenance of all data during batteries replacement.
- Microprocessor and CMOS circuits.
- double insulation.
- Protection degree IP20.
- Unit weight 0,22 Kg.

