

HEAT RECOVERY UNIT

UVR-HE SERIES

- ➔ Ceiling, false ceiling or floor mounting
- ➔ 13 single-phase Models
- ➔ Capacity from 650 to 8.500 m³/h
- ➔ Equipped with cross-flow high efficiency heat exchangers from 73% to 88%
- ➔ RCE-EC remote control unit included
- ➔ In accordance with the 2009/125/CE Directive and Regulation no. 1253/2014 (Ecodesign 2018)



>73%

CE

ECO
design
2018



DESCRIPTION:

Double flow ventilation unit made with external galvanized steel sheet and high-efficiency cross flow heat recovery unit.

Suitable to ventilate small and medium-size rooms in tertiary and commercial sectors such as pubs, restaurants, offices, meeting rooms, shops, gyms, dance halls, canteens, etc.

FEATURES:

- Equipped with EC (high-efficiency) electrical fans. Forward bladed double inlet fans, installed in Models of size 1600 and greater, already comply with both IE5 and ERP2020 efficiency limits.
- External structure in galvanized steel sheet;
- Thermal and acoustic isolation with 23 mm thick polyurethane (40 Kh/m³);
- Insulator with fireproof sound-absorbing mattress placed on the lower and upper panels;
- Motors can be adjusted separately;
- Two temperature probes: first probe for the delivery air and second probe for the return air;
- Motorized internal by-pass shutter adjustable both manually and automatically;

- Pressure-switch to measure the filter stoppage level
- Control board set to connect a CO₂ or humidity probe (optional);
- Equipped electric control board is IP 55 protected; all units can be mounted/installed outdoor when equipped with a cover.
- Centrifugal fans with reverse blades (UVR-HE 500, UVR-HE 700, UVR-HE 1200 Models);
- Centrifugal fans with forward blades (from UVR-HE 1600 to UVR-HE 8500 Models);
- Equipped with an RS485 port that allows:
 - connection to a single "DeG" remote controller;
 - full compatibility with the MODBUS interface;
 - up to six base controllers can be linked together using a cascade connection and be managed using a single "DeG" remote controller.
- Filters can be easily inspected and replaced through proper portholes placed on the unit cover;
- M6 filter for the external exhaust air;
- FT filter for the renewal delivery air;
- Aerulic configuration can be implemented also in the building site;
- RCE-EC remote control unit included;

- Mounting brackets included;
- Condensation collection tray including condensate drain;
- EUROVENT certified heat exchanger.

- Detection of the external and internal temperatures;
- Fan mode control according to CO₂ air quality (optional);

REMOTE CONTROL UNIT:

- RCE-EC remote control unit with monochrome display;
- Remote control of the UVR-HE units with manual or automatic functioning;
- Flush mounting in 3-module boxes (503 type);
- LED light to indicate the filter stoppage status;
- Manual and automatic by-pass control;
- Control of the two fans in coupled or separate mode;

ACCESSORIES:

- Post-heating hydronic batteries;
- Post-cooling hydronic batteries;
- Pre and post-heating electric batteries;
- Inspectable filter box.

CONFIGURATION

REVERSE BLADES (configurable in the building site)

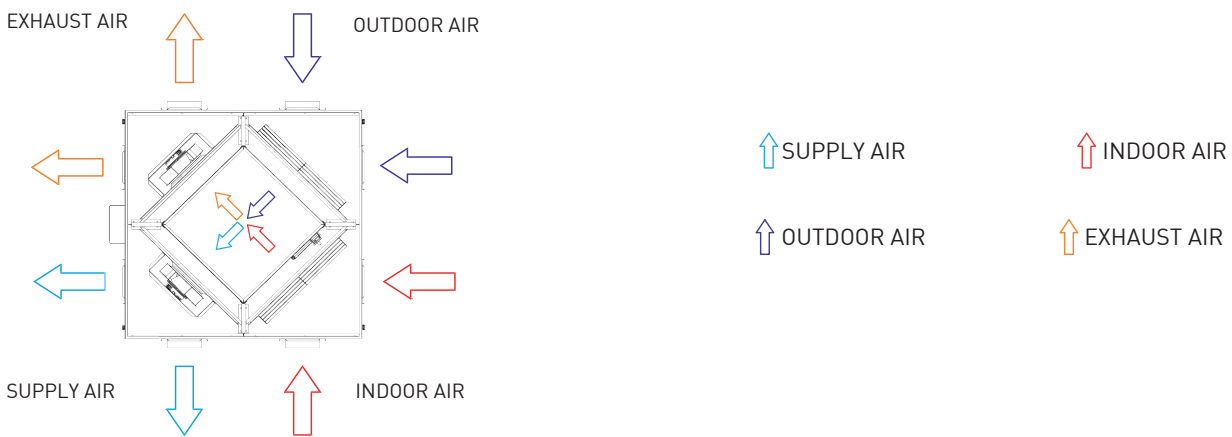

FORWARD BLADES (configurable on request)

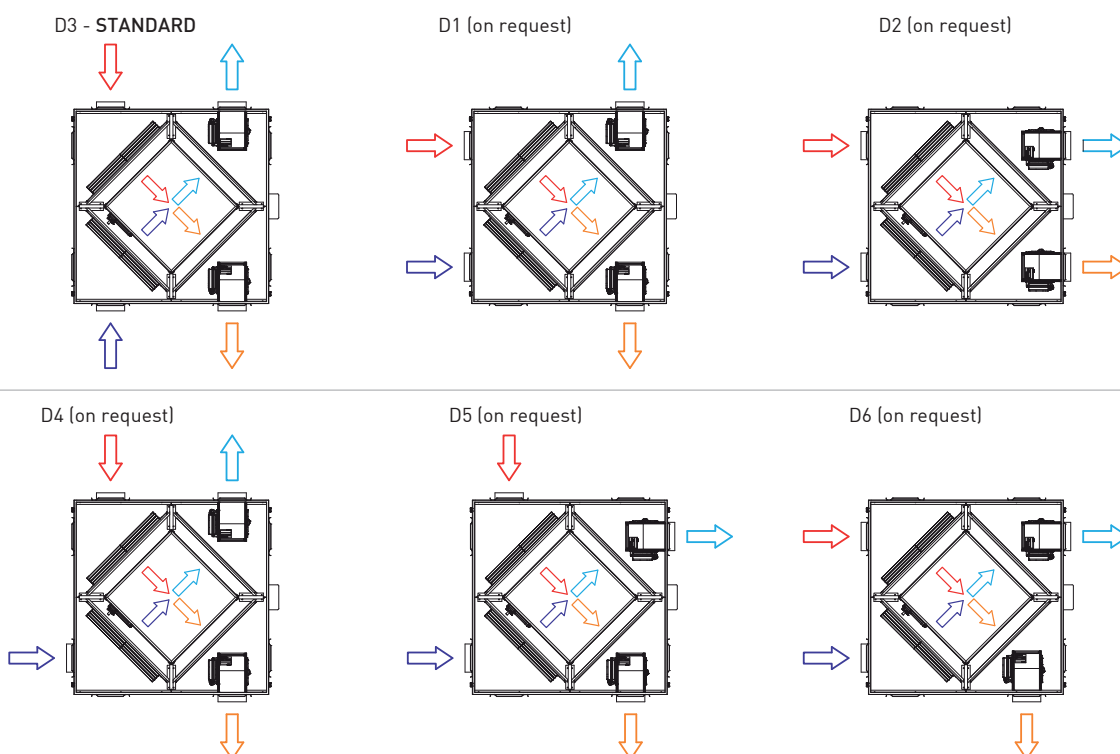

DIMENSIONS

CODE	MODEL	mm								
		A1	A2	B	C	D	ØE	F	G	Kg
AP20071	UVR 500 MF HE	850	850	755	910	380	150	175	500	55,0
AP20073	UVR 700 MF HE	1000	1000	905	1060	380	150	250	500	64,0
AP20075	UVR 1200 MF HE	1000	1000	905	1060	380	180	250	500	80,0
AP20077	UVR 1600 MF HE	1200	1200	1105	1260	525	250	300	600	110,0
AP20079	UVR 2300 MF HE	1200	1200	1105	1260	525	315	300	600	124,0
AP20081	UVR 2800 MF HE	1350	1350	1255	1410	575	315	300	750	161,0
AP20083	UVR 3200 MF HE	1350	1350	1255	1410	675	350	300	750	178,0
AP20085	UVR 3800 MF HE	1350	1350	1255	1410	675	350	325	700	188,0
AP20087	UVR 4500 MF HE	1350	1350	1255	1410	775	350	300	750	215,0
AP20089	UVR 5400 MF HE	1650	1650	1080	1710	775	350	285	1080	302,0
AP20091	UVR 6500 MF HE	1650	1650	1080	1710	775	450	355	940	302,0
AP20093	UVR 7100 MF HE	2150	2150	-	2210	1100	600	425	1300	500,0
AP20095	UVR 8500 MF HE	2150	2150	-	2210	1100	600	425	1300	500,0

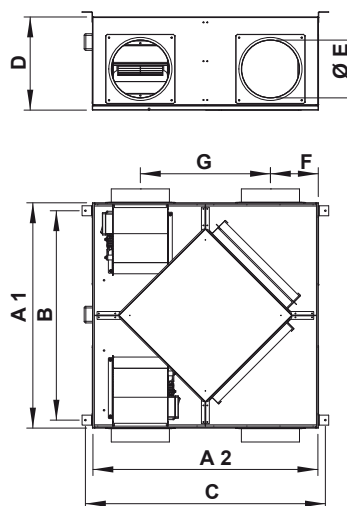
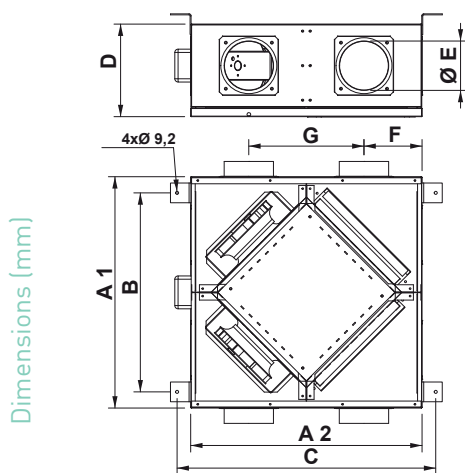

REVERSE BLADES

- UVR 500 MF HE
- UVR 700 MF HE
- UVR 1200 MF HE

FORWARD BLADES

- UVR 1600 MF HE
- UVR 2300 MF HE
- UVR 2800 MF HE
- UVR 3200 MF HE
- UVR 3800 MF HE
- UVR 4500 MF HE
- UVR 5400 MF HE
- UVR 6500 MF HE
- UVR 7100 MF HE
- UVR 8500 MF HE

TECHNICAL SPECIFICATIONS

CODE	MODEL	hmax. m ³ /	max Pa	Nominal flow rate Q _{nom}	W	A	V~	Hz	Ph	dB(A) [1m]	dB(A) [3m]
AP20071	UVR 500 MF HE	650	470	620	2x120	0,84	230	50/60	1	51	46
AP20073	UVR 700 MF HE	750	470	720	2x120	0,84	230	50/60	1	51	46
AP20075	UVR 1200 MF HE	1200	600	1120	2x270	1,76	230	50/60	1	51	46
AP20077	UVR 1600 MF HE	1600	750	1580	2x270	1,76	230	50/60	1	59	53
AP20079	UVR 2300 MF HE	2300	500	1780	2x1070	2,9	230	50/60	1	60	55
AP20081	UVR 2800 MF HE	2800	650	2160	2x1070	4,4	230	50/60	1	61	56
AP20083	UVR 3200 MF HE	3200	650	2540	2x1040	4,5	230	50/60	1	62	56
AP20085	UVR 3800 MF HE	3800	800	2760	2x1040	4,5	230	50/60	1	62	56
AP20087	UVR 4500 MF HE	4500	650	2680	2x2200	5,6	230	50/60	1	63	57
AP20089	UVR 5400 MF HE	5400	830	4780	2x2200	8,6	230	50/60	1	64	59
AP20091	UVR 6500 MF HE	6500	1200	4880	2x2310	9,4	230	50/60	1	63	61
AP20093	UVR 7100 MF HE	7100	1100	5140	2x2370	9,3	230	50/60	1	65	62
AP20095	UVR 8500 MF HE	8500	830	6460	2x2380	9,8	230	50/60	1	66	63

CHARACTERISTIC CURVES

AP20071 - UVR 500 MF HE

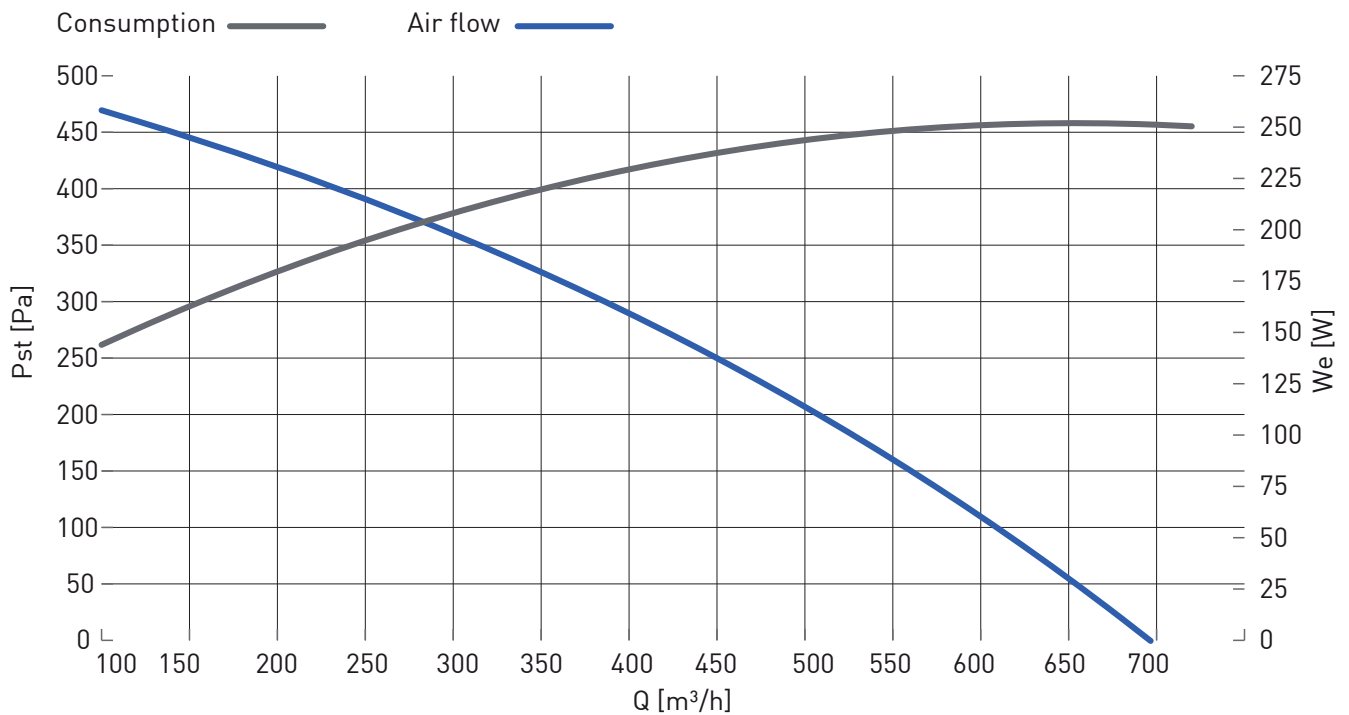

THERMAL EFFICIENCY OF HEAT RECOVERY

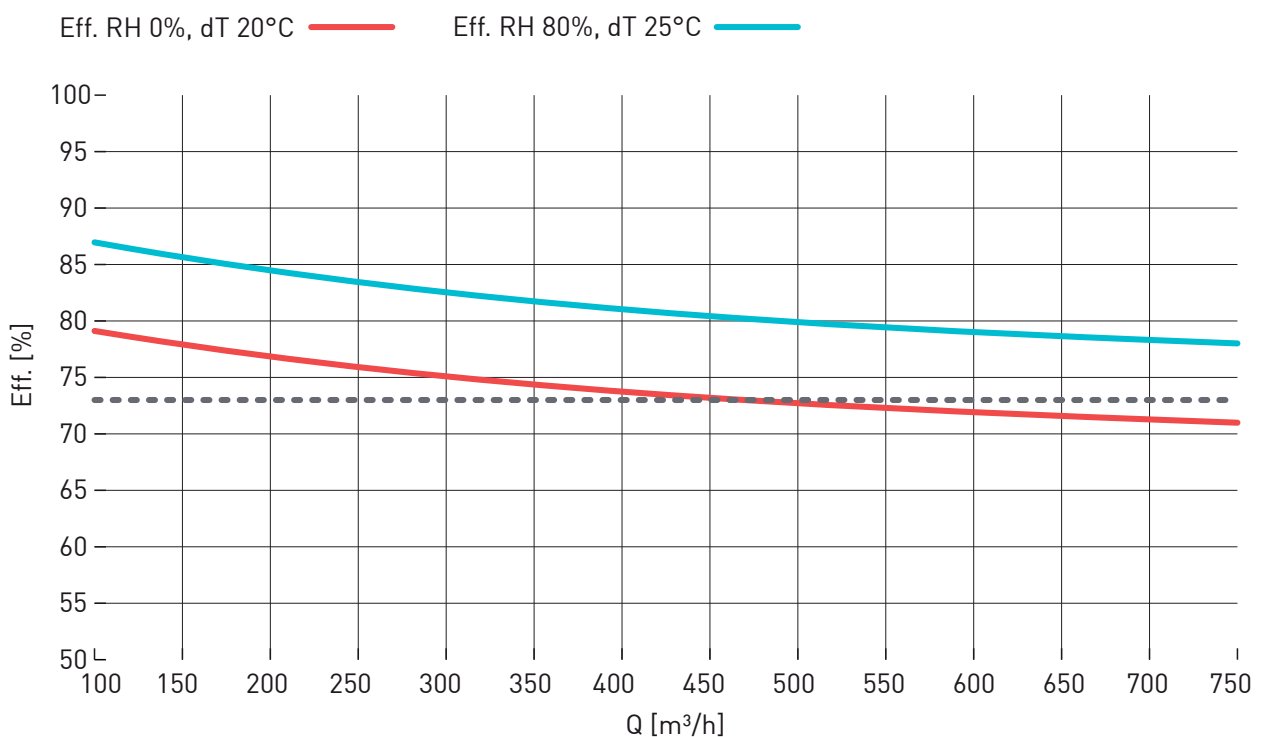

MAXIMUM THERMAL EFFICIENCY OF HEAT RECOVERY (EN 308)

87.0%

External temperature -5 °C - R.H. 80%

Exhaust air +20 °C - R.H. 50%

NOMINAL DATA (DIRECTIVE AND REGULATION NO. 1253/2014 ECODESIGN 2018)

Producer	Fantini Cosmi SpA	
Item N°	AP20071	
Model	UVR 500 MF HE	
Typology of ventilation unit	UVNR, UVB	
Type of drive	MSD (multiple speed drive)	
Type of heat recovery system	air/air heat recovery system	
Nominal flow rate (qnom)	[m³/h]	620
	[m³/s]	0,172
Electrical power input (We,tot)	[W]	252
Internal specific fan power (SFPint)	[W/(m³/s)]	1053
Internal specific fan power, 2018 limit	[W/(m³/s)]	1074
Face velocity	[m/s]	1,7
Nominal external pressure ($\Delta p_{s,ext}$)	[Pa]	88
Internal pressure drop of ventilation components ($\Delta p_{s,int}$), mandata	[Pa]	238
Internal pressure drop of ventilation components ($\Delta p_{s,int}$), return	[Pa]	242
Thermal efficiency of HRS (nt, dry air, ΔT 20 [°C])	[%]	73,2
Static efficiency of fan (according Regulation UE n. 327/2011)	[%]	45,5
Casing sound power level (LWA)	[dB]	72
External leakage	max 3,5 @ -400 Pa	(EN 13141-7)
Internal leakage	max 5,5 @ +250 Pa	(EN 13141-7)
Web address	www.fantinicosmi.it	
In accordance with the Regulation (UE) N° 1253/2014	2018 compliant product	

CHARACTERISTIC CURVES

AP20073 - UVR 700 MF HE

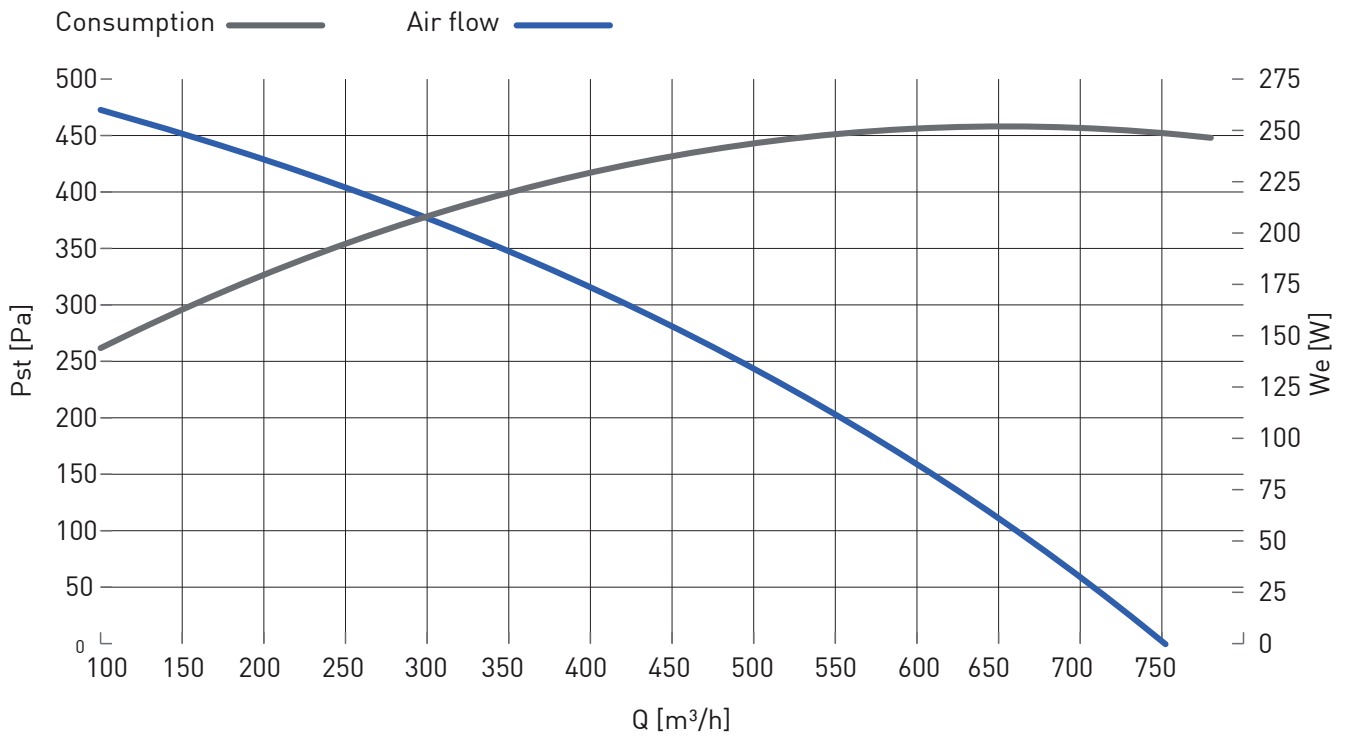

THERMAL EFFICIENCY OF HEAT RECOVERY

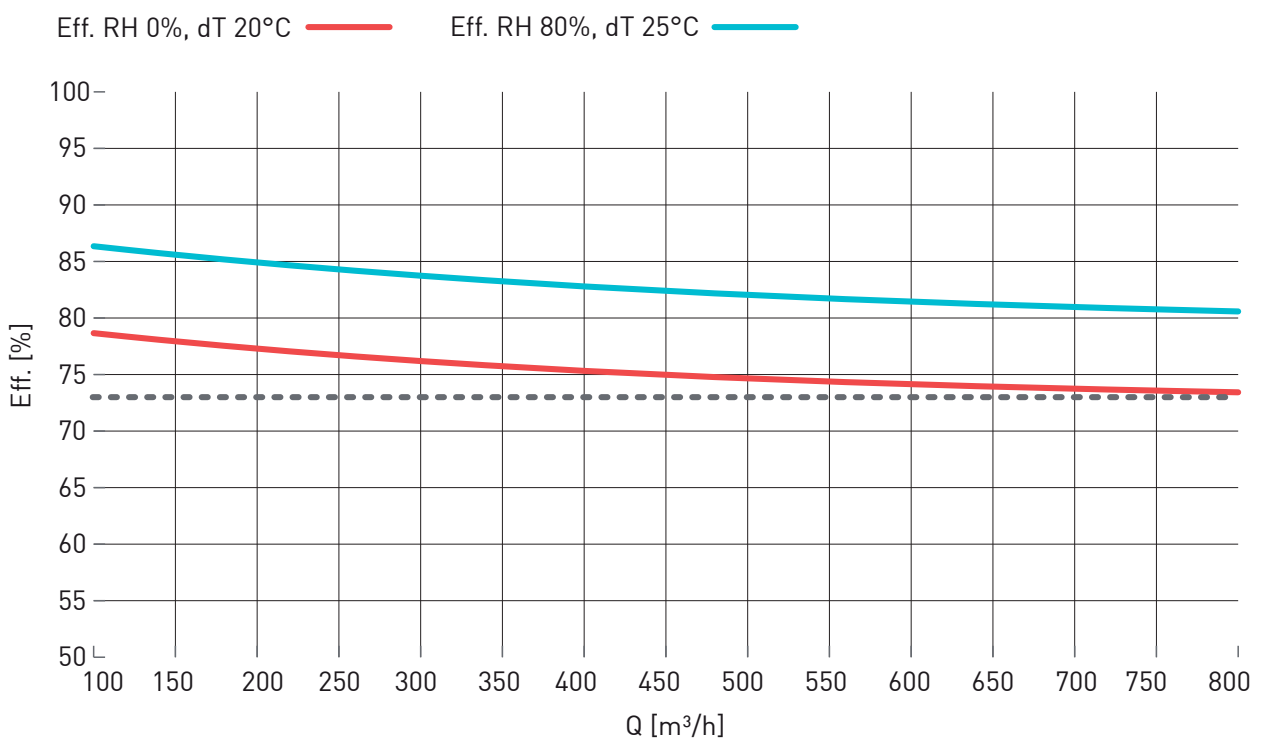

MAXIMUM THERMAL EFFICIENCY OF HEAT RECOVERY (EN 308)

86.0%

External temperature -5 °C - R.H. 80%

Exhaust air +20 °C - R.H. 50%

NOMINAL DATA (DIRECTIVE AND REGULATION NO. 1253/2014 ECODESIGN 2018)

Producer	Fantini Cosmi SpA	
Item N°	AP20073	
Model	UVR 700 MF HE	
Typology of ventilation unit	UVNR, UVB	
Type of drive	MSD (multiple speed drive)	
Type of heat recovery system	air/air heat recovery system	
Nominal flow rate (qnom)	[m³/h]	720
	[m³/s]	0,2
Electrical power input (We,tot)	[W]	250
Internal specific fan power (SFPint)	[W/(m³/s)]	1076
Internal specific fan power, 2018 limit	[W/(m³/s)]	1090
Face velocity	[m/s]	1,5
Nominal external pressure ($\Delta p_{s,ext}$)	[Pa]	37
Internal pressure drop of ventilation components ($\Delta p_{s,int}$), mandata	[Pa]	241
Internal pressure drop of ventilation components ($\Delta p_{s,int}$), return	[Pa]	246
Thermal efficiency of HRS (nt, dry air, ΔT 20 [°C])	[%]	73,7
Static efficiency of fan (according Regulation UE n. 327/2011)	[%]	45,5
Casing sound power level (LWA)	[dB]	72
External leakage	max 3,5 @ -400 Pa	(EN 13141-7)
Internal leakage	max 5,5 @ +250 Pa	(EN 13141-7)
Web address	www.fantinosmi.it	
In accordance with the Regulation (UE) N° 1253/2014	2018 compliant product	

CHARACTERISTIC CURVES

AP20075 - UVR 1200 MF HE

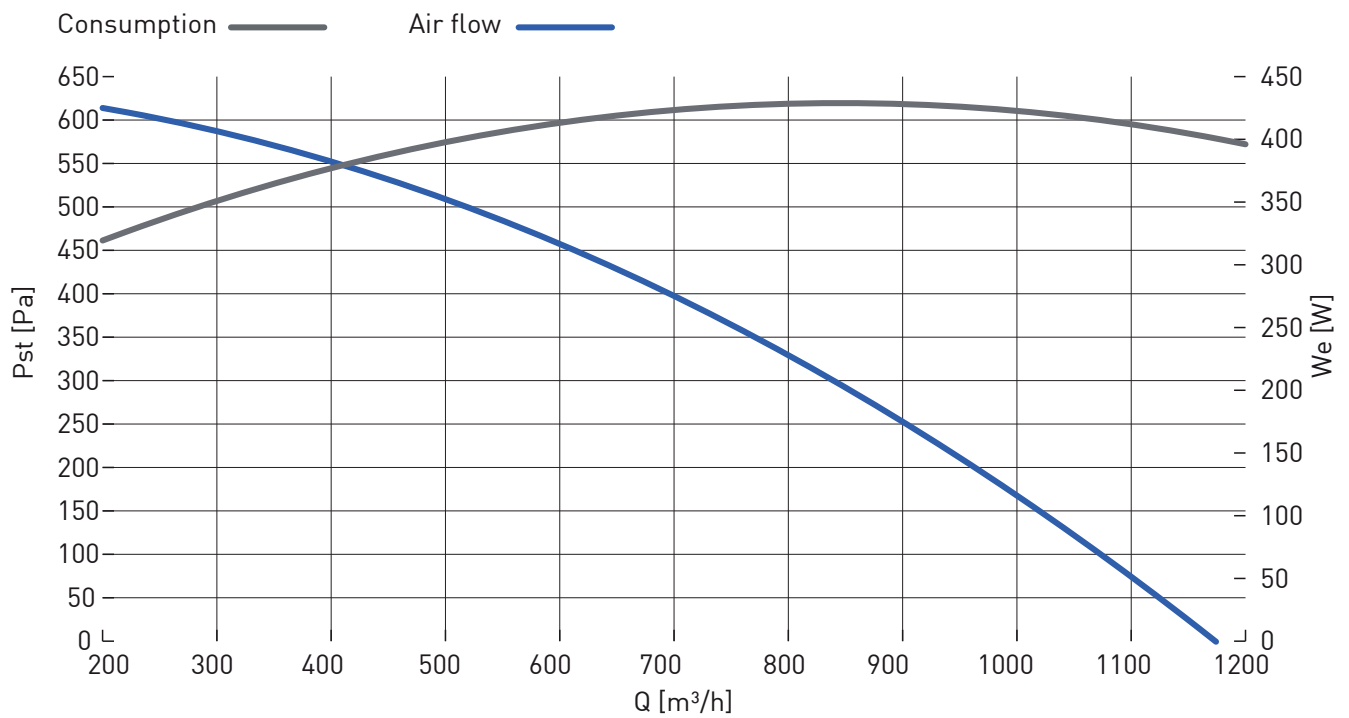

THERMAL EFFICIENCY OF HEAT RECOVERY

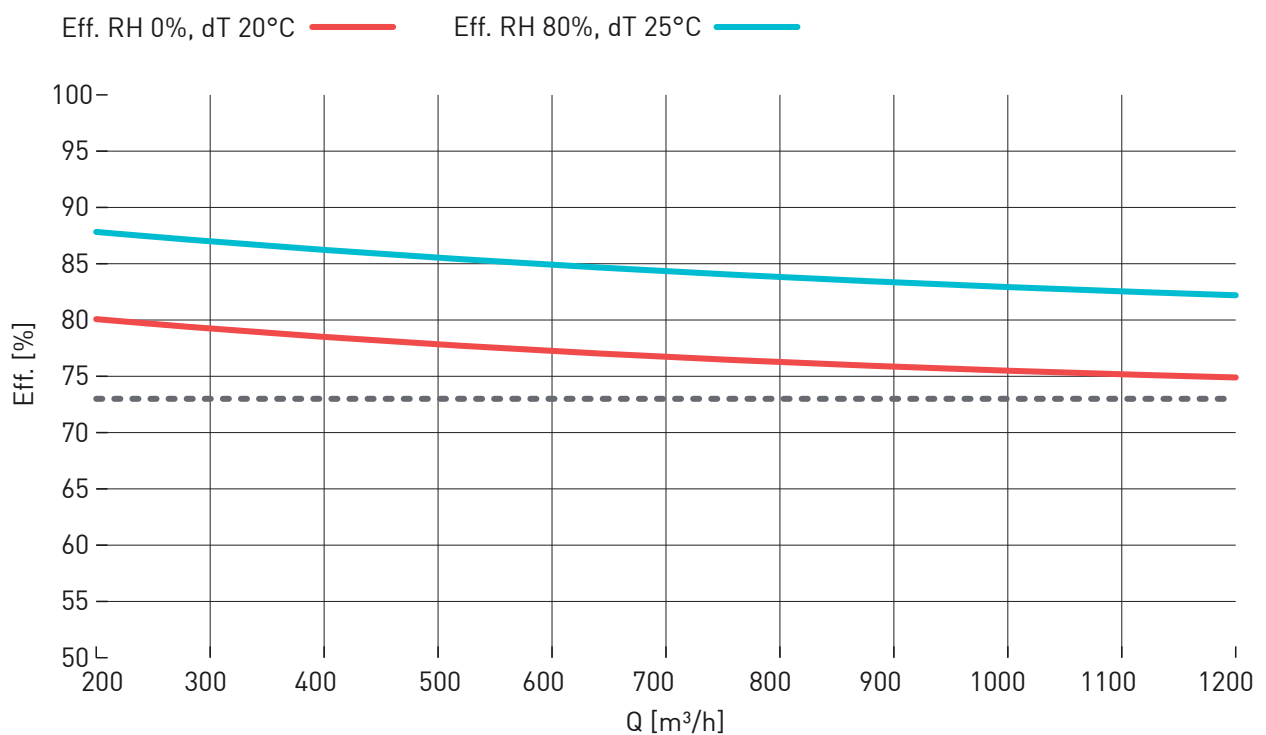

MAXIMUM THERMAL EFFICIENCY OF HEAT RECOVERY (EN 308)

88.0%

External temperature -5 °C - R.H. 80%

Exhaust air +20 °C - R.H. 50%

NOMINAL DATA (DIRECTIVE AND REGULATION NO. 1253/2014 ECODESIGN 2018)

Producer	Fantini Cosmi SpA	
Item N°	AP20075	
Model	UVR 1200 MF HE	
Typology of ventilation unit	UVNR, UVB	
Type of drive	MSD (multiple speed drive)	
Type of heat recovery system	air/air heat recovery system	
Nominal flow rate (qnom)	[m³/h]	1120
	[m³/s]	0,311
Electrical power input (We,tot)	[W]	409
Internal specific fan power (SFPint)	[W/(m³/s)]	1076
Internal specific fan power, 2018 limit	[W/(m³/s)]	1117
Face velocity	[m/s]	1,5
Nominal external pressure ($\Delta p_{s,ext}$)	[Pa]	54
Internal pressure drop of ventilation components ($\Delta p_{s,int}$), mandata	[Pa]	257
Internal pressure drop of ventilation components ($\Delta p_{s,int}$), return	[Pa]	262
Thermal efficiency of HRS (nt, dry air, ΔT 20 [°C])	[%]	75,1
Static efficiency of fan (according Regulation UE n. 327/2011)	[%]	52,0
Casing sound power level (LWA)	[dB]	72
External leakage	max 3,5 @ -400 Pa	(EN 13141-7)
Internal leakage	max 5,5 @ +250 Pa	(EN 13141-7)
Web address	www.fantincosmi.it	
In accordance with the Regulation (UE) N° 1253/2014	2018 compliant product	

CHARACTERISTIC CURVES

AP20077 - UVR 1600 MF HE

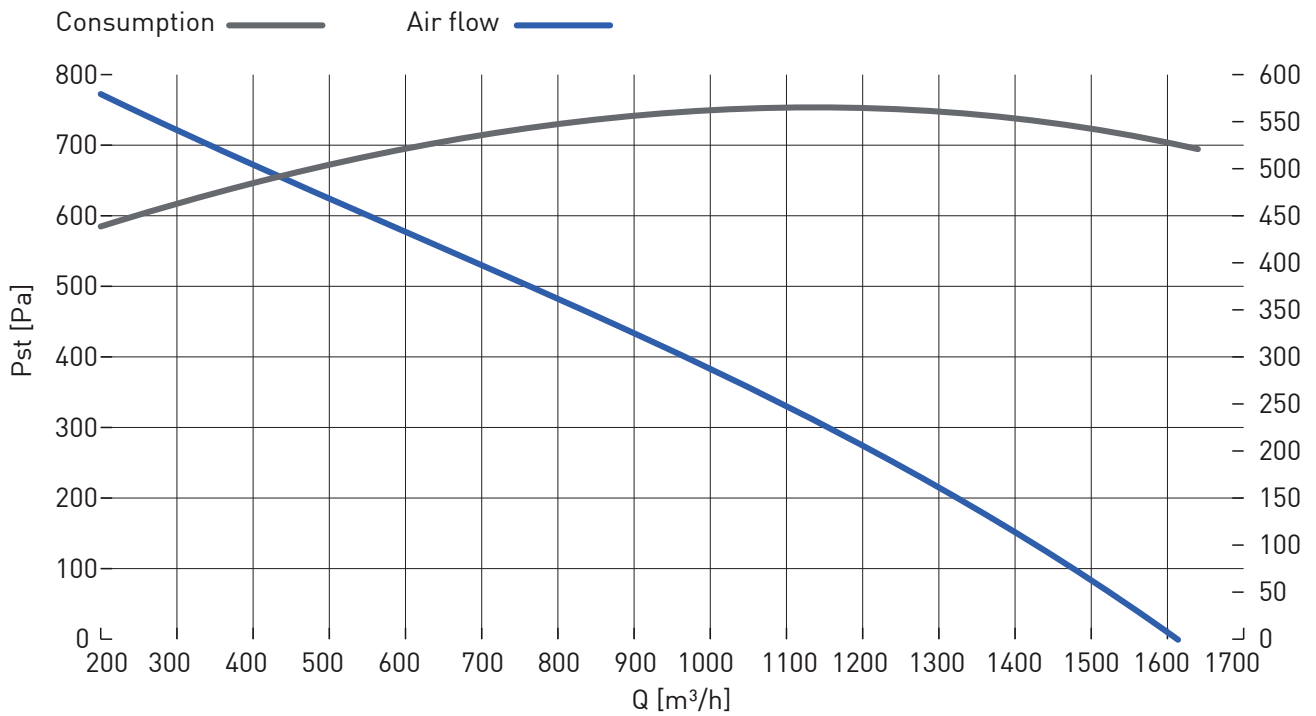

THERMAL EFFICIENCY OF HEAT RECOVERY

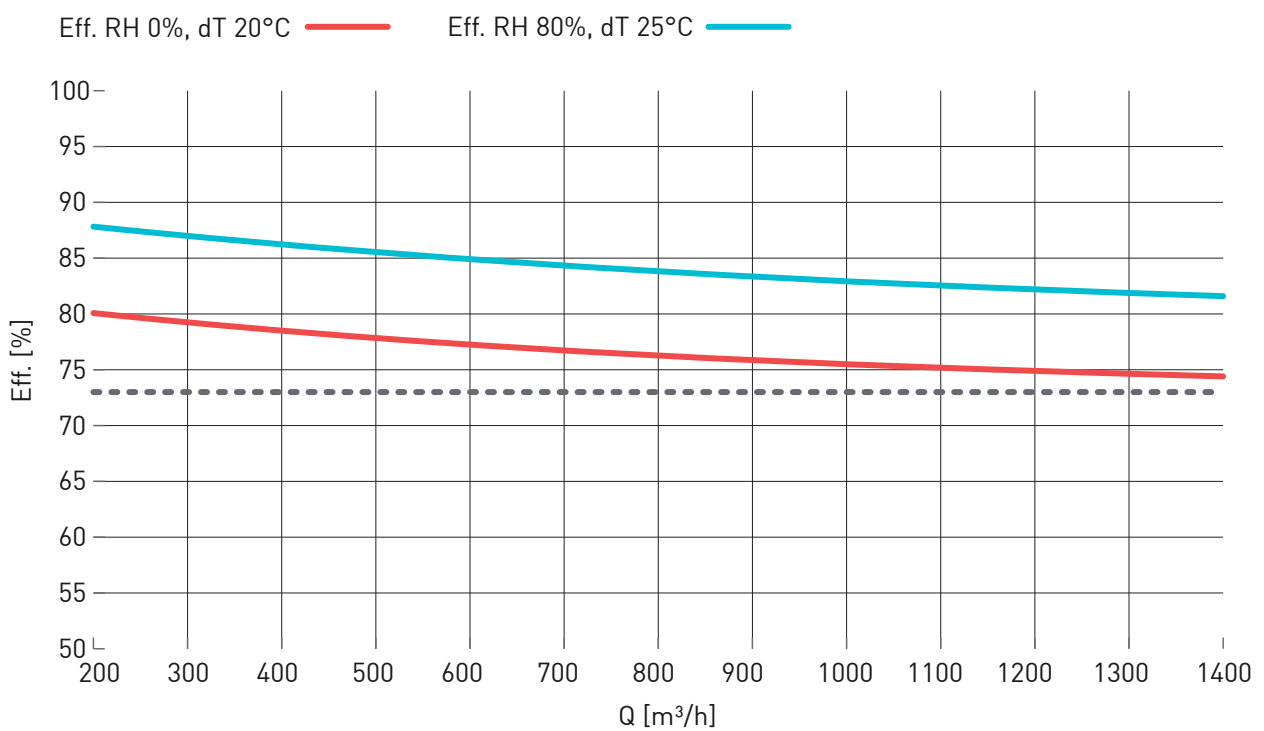

MAXIMUM THERMAL EFFICIENCY OF HEAT RECOVERY (EN 308)

88.0%

External temperature -5 °C - R.H. 80%

Exhaust air +20 °C - R.H. 50%

NOMINAL DATA (DIRECTIVE AND REGULATION NO. 1253/2014 ECODESIGN 2018)

Producer	Fantini Cosmi SpA	
Item N°	AP20077	
Model	UVR 1600 MF HE	
Typology of ventilation unit	UVNR, UVB	
Type of drive	MSD (multiple speed drive)	
Type of heat recovery system	air/air heat recovery system	
Nominal flow rate (qnom)	[m³/h]	1580
	[m³/s]	0,439
Electrical power input (We,tot)	[W]	531
Internal specific fan power (SFPint)	[W/(m³/s)]	1089
Internal specific fan power, 2018 limit	[W/(m³/s)]	1104
Face velocity	[m/s]	1,5
Nominal external pressure ($\Delta p_{s,ext}$)	[Pa]	251
Internal pressure drop of ventilation components ($\Delta p_{s,int}$), mandata	[Pa]	255
Internal pressure drop of ventilation components ($\Delta p_{s,int}$), return	[Pa]	260
Thermal efficiency of HRS (nt, dry air, ΔT 20 [°C])	[%]	75,3
Static efficiency of fan (according Regulation UE n. 327/2011)	[%]	52,0
Casing sound power level (LWA)	[dB]	72
External leakage	max 3,5 @ -400 Pa	(EN 13141-7)
Internal leakage	max 5,5 @ +250 Pa	(EN 13141-7)
Web address	www.fantincosmi.it	
In accordance with the Regulation (UE) N° 1253/2014	2018 compliant product	

CHARACTERISTIC CURVES

AP20079 - UVR 2300 MF HE

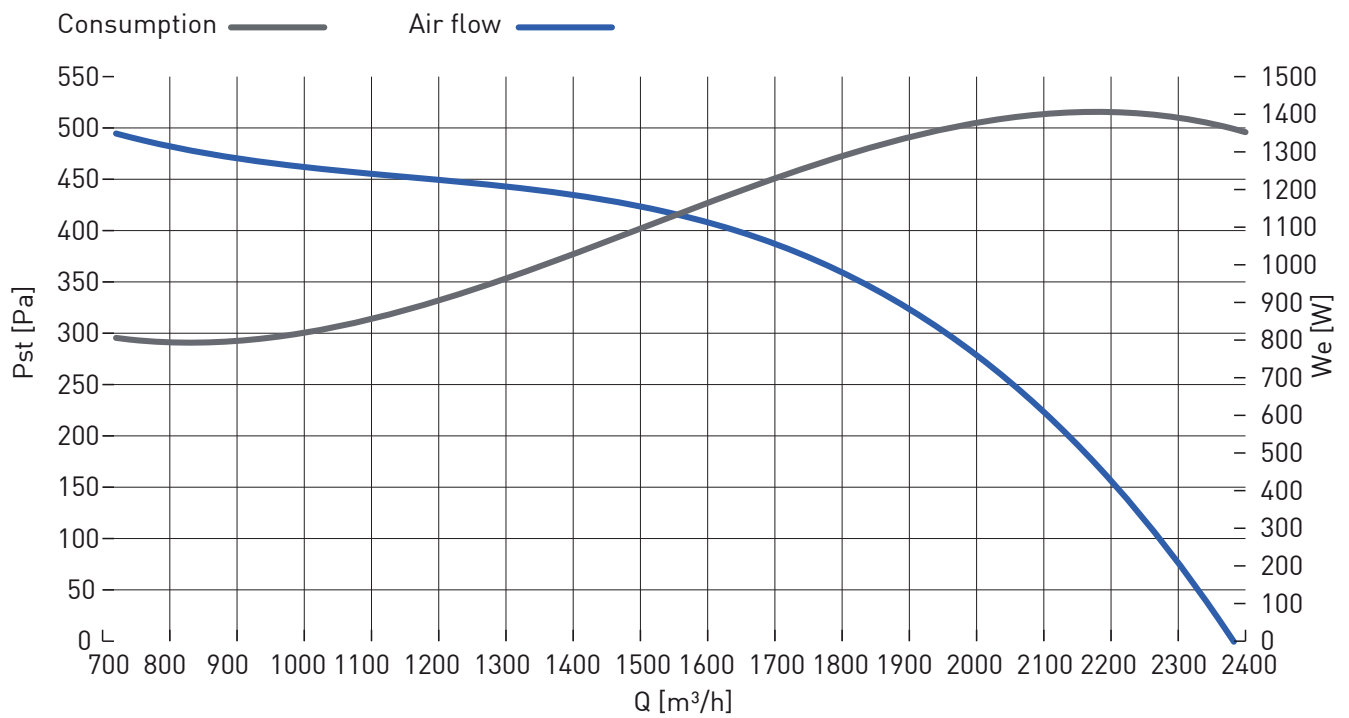

THERMAL EFFICIENCY OF HEAT RECOVERY

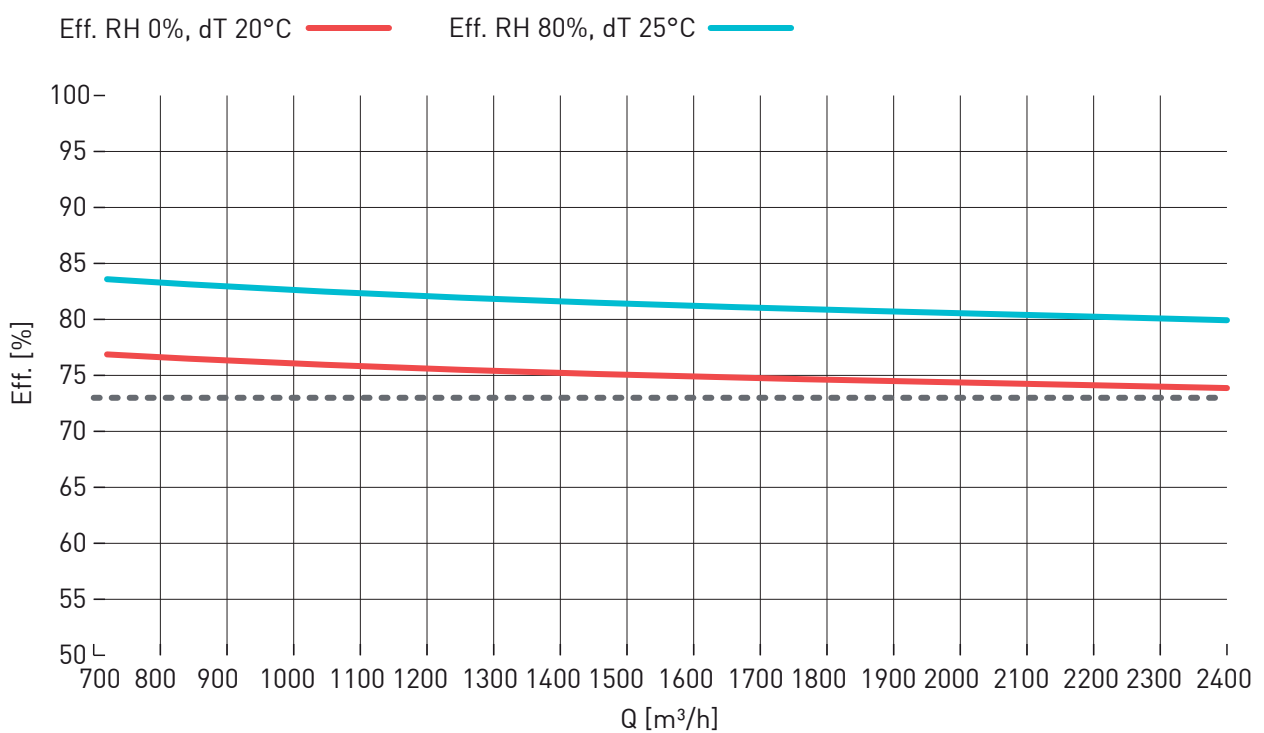

MAXIMUM THERMAL EFFICIENCY OF HEAT RECOVERY (EN 308)

84.0%

External temperature -5 °C - R.H. 80%

Exhaust air +20 °C - R.H. 50%

NOMINAL DATA (DIRECTIVE AND REGULATION NO. 1253/2014 ECODESIGN 2018)

Producer	Fantini Cosmi SpA	
Item N°	AP20079	
Model	UVR 2300 MF HE	
Typology of ventilation unit	UVNR, UVB	
Type of drive	MSD (multiple speed drive)	
Type of heat recovery system	air/air heat recovery system	
Nominal flow rate (qnom)	[m ³ /h]	1780
	[m ³ /s]	0,494
Electrical power input (We,tot)	[W]	1277
Internal specific fan power (SFPint)	[W/(m ³ /s)]	1070
Internal specific fan power, 2018 limit	[W/(m ³ /s)]	1075
Face velocity	[m/s]	1,7
Nominal external pressure ($\Delta p_{s,ext}$)	[Pa]	365
Internal pressure drop of ventilation components ($\Delta p_{s,int}$), mandata	[Pa]	264
Internal pressure drop of ventilation components ($\Delta p_{s,int}$), return	[Pa]	269
Thermal efficiency of HRS (nt, dry air, ΔT 20 [°C])	[%]	74,6
Static efficiency of fan (according Regulation UE n. 327/2011)	[%]	53,2
Casing sound power level (LWA)	[dB]	102
External leakage	max 3,5 @ -400 Pa	(EN 13141-7)
Internal leakage	max 5,5 @ +250 Pa	(EN 13141-7)
Web address	www.fantinosmi.it	
In accordance with the Regulation (UE) N° 1253/2014	2018 compliant product	

CHARACTERISTIC CURVES

AP20081 - UVR 2800 MF HE

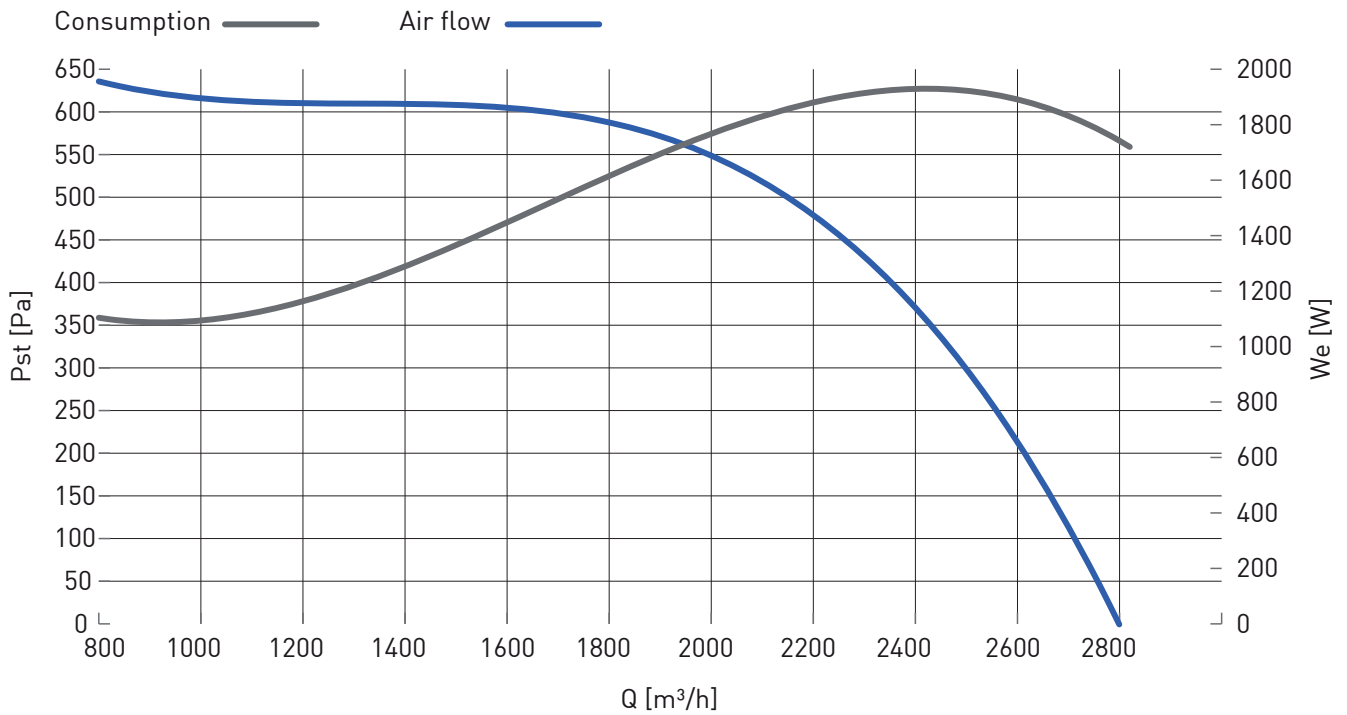

THERMAL EFFICIENCY OF HEAT RECOVERY

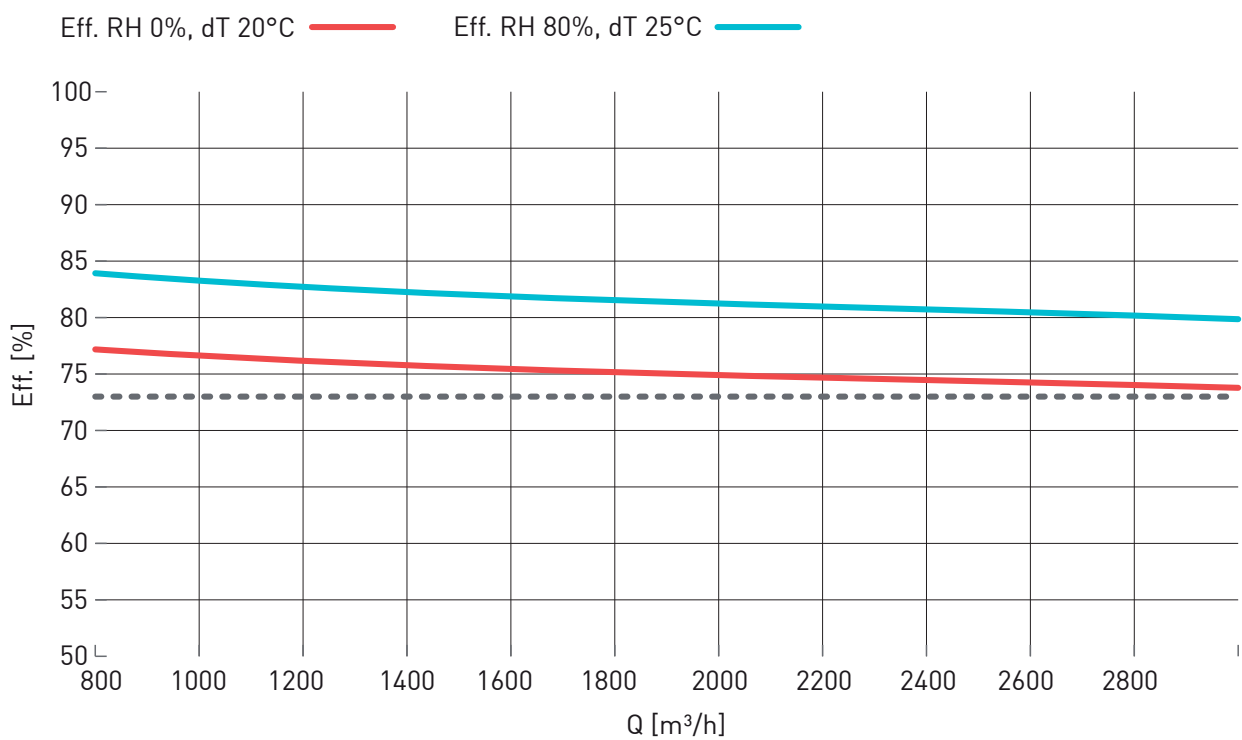

MAXIMUM THERMAL EFFICIENCY OF HEAT RECOVERY (EN 308)

84.0%

External temperature -5 °C - R.H. 80%

Exhaust air +20 °C - R.H. 50%

NOMINAL DATA (DIRECTIVE AND REGULATION NO. 1253/2014 ECODESIGN 2018)

Producer	Fantini Cosmi SpA	
Item N°	AP20081	
Model	UVR 2800 MF HE	
Typology of ventilation unit	UVNR, UVB	
Type of drive	MSD (multiple speed drive)	
Type of heat recovery system	air/air heat recovery system	
Nominal flow rate (qnom)	[m³/h]	2160
	[m³/s]	0,600
Electrical power input (We,tot)	[W]	1862
Internal specific fan power (SFPint)	[W/(m³/s)]	1043
Internal specific fan power, 2018 limit	[W/(m³/s)]	1062
Face velocity	[m/s]	1,7
Nominal external pressure ($\Delta p_{s,ext}$)	[Pa]	496
Internal pressure drop of ventilation components ($\Delta p_{s,int}$), mandata	[Pa]	256
Internal pressure drop of ventilation components ($\Delta p_{s,int}$), return	[Pa]	261
Thermal efficiency of HRS (nt, dry air, ΔT 20 [°C])	[%]	74,7
Static efficiency of fan (according Regulation UE n. 327/2011)	[%]	53,2
Casing sound power level (LWA)	[dB]	68,2
External leakage	max 3,5 @ -400 Pa	(EN 13141-7)
Internal leakage	max 5,5 @ +250 Pa	(EN 13141-7)
Web address	www.fantinosmi.it	
In accordance with the Regulation (UE) N° 1253/2014	2018 compliant product	

CHARACTERISTIC CURVES

AP20083 - UVR 3200 MF HE

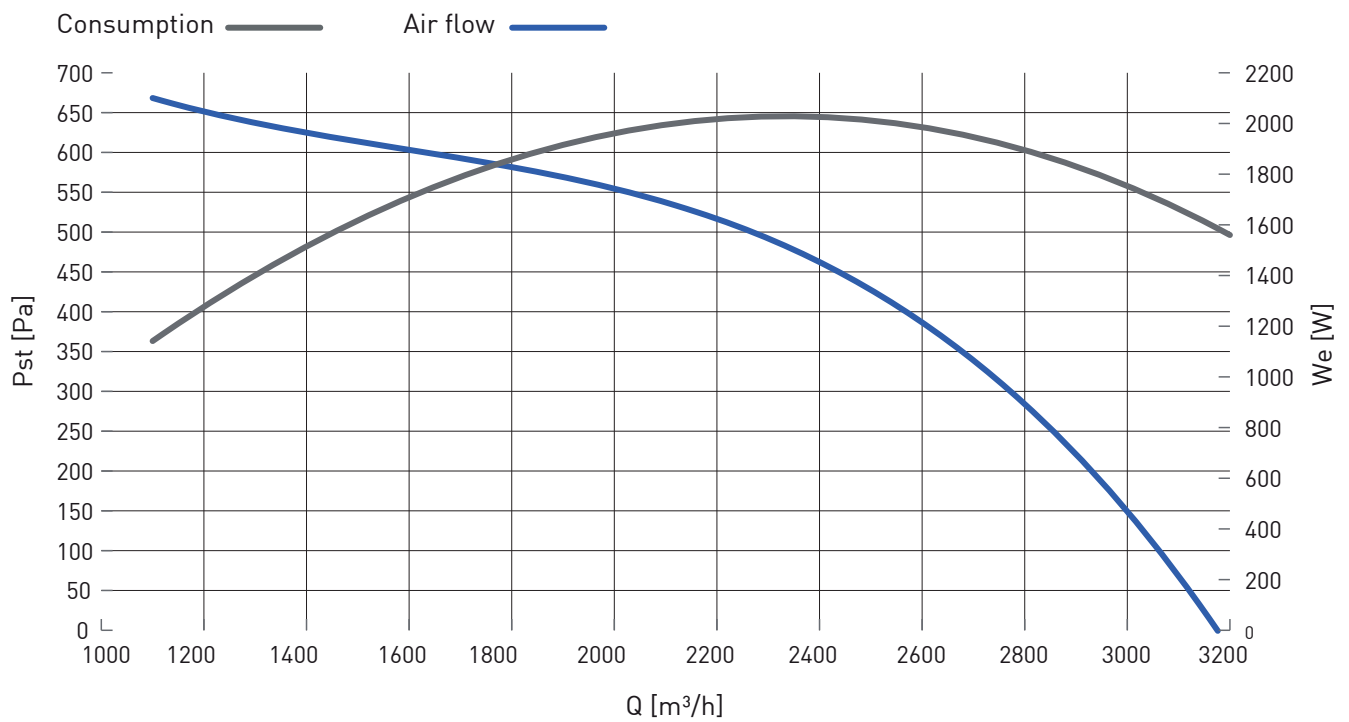

THERMAL EFFICIENCY OF HEAT RECOVERY

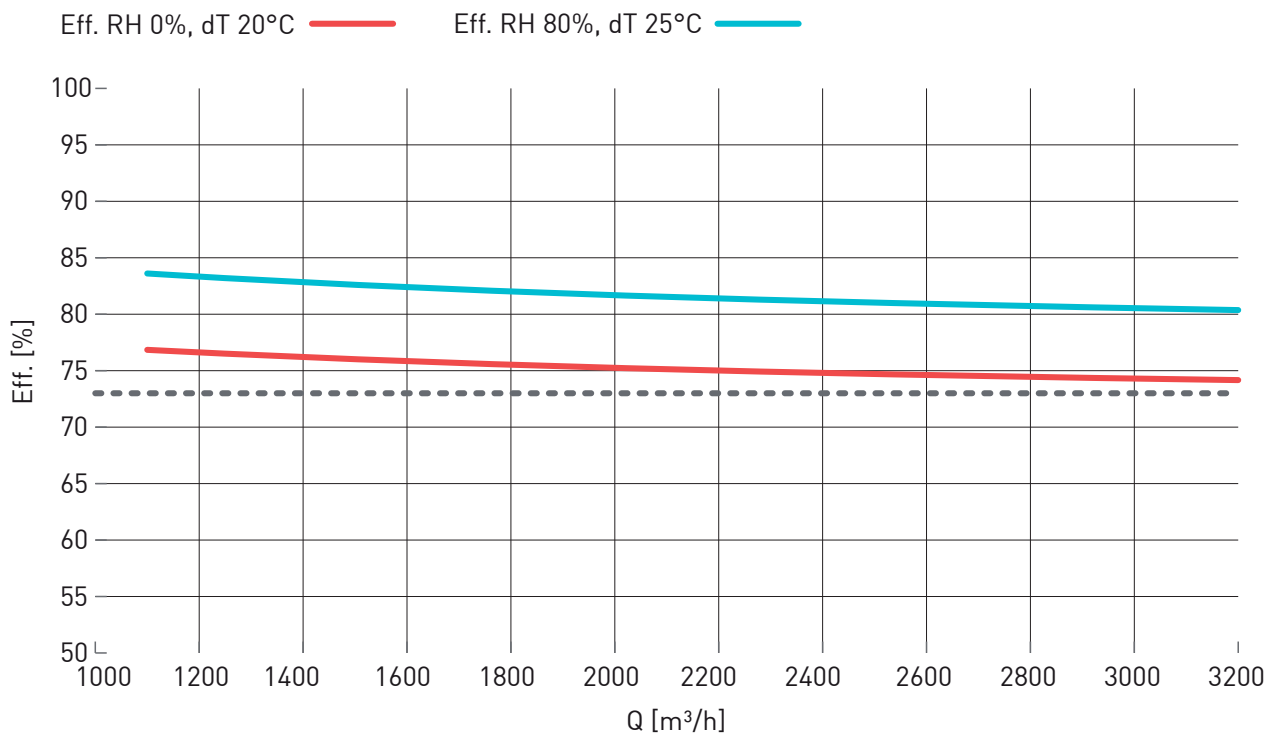

MAXIMUM THERMAL EFFICIENCY OF HEAT RECOVERY (EN 308)

84.0%

External temperature -5 °C - R.H. 80%

Exhaust air +20 °C - R.H. 50%

NOMINAL DATA (DIRECTIVE AND REGULATION NO. 1253/2014 ECODESIGN 2018)

Producer	Fantini Cosmi SpA	
Item N°	AP20083	
Model	UVR 3200 MF HE	
Typology of ventilation unit	UVNR, UVB	
Type of drive	MSD (multiple speed drive)	
Type of heat recovery system	air/air heat recovery system	
Nominal flow rate (qnom)	[m³/h]	2540
	[m³/s]	0,706
Electrical power input (We,tot)	[W]	2003
Internal specific fan power (SFPint)	[W/(m³/s)]	1038
Internal specific fan power, 2018 limit	[W/(m³/s)]	1044
Face velocity	[m/s]	1,6
Nominal external pressure ($\Delta p_{s,ext}$)	[Pa]	412
Internal pressure drop of ventilation components ($\Delta p_{s,int}$), mandata	[Pa]	243
Internal pressure drop of ventilation components ($\Delta p_{s,int}$), return	[Pa]	247
Thermal efficiency of HRS (nt, dry air, ΔT 20 [°C])	[%]	74,7
Static efficiency of fan (according Regulation UE n. 327/2011)	[%]	55,9
Casing sound power level (LWA)	[dB]	94
External leakage	max 3,5 @ -400 Pa	(EN 13141-7)
Internal leakage	max 5,5 @ +250 Pa	(EN 13141-7)
Web address	www.fantinosmi.it	
In accordance with the Regulation (UE) N° 1253/2014	2018 compliant product	

CHARACTERISTIC CURVES

AP20085 - UVR 3800 MF HE

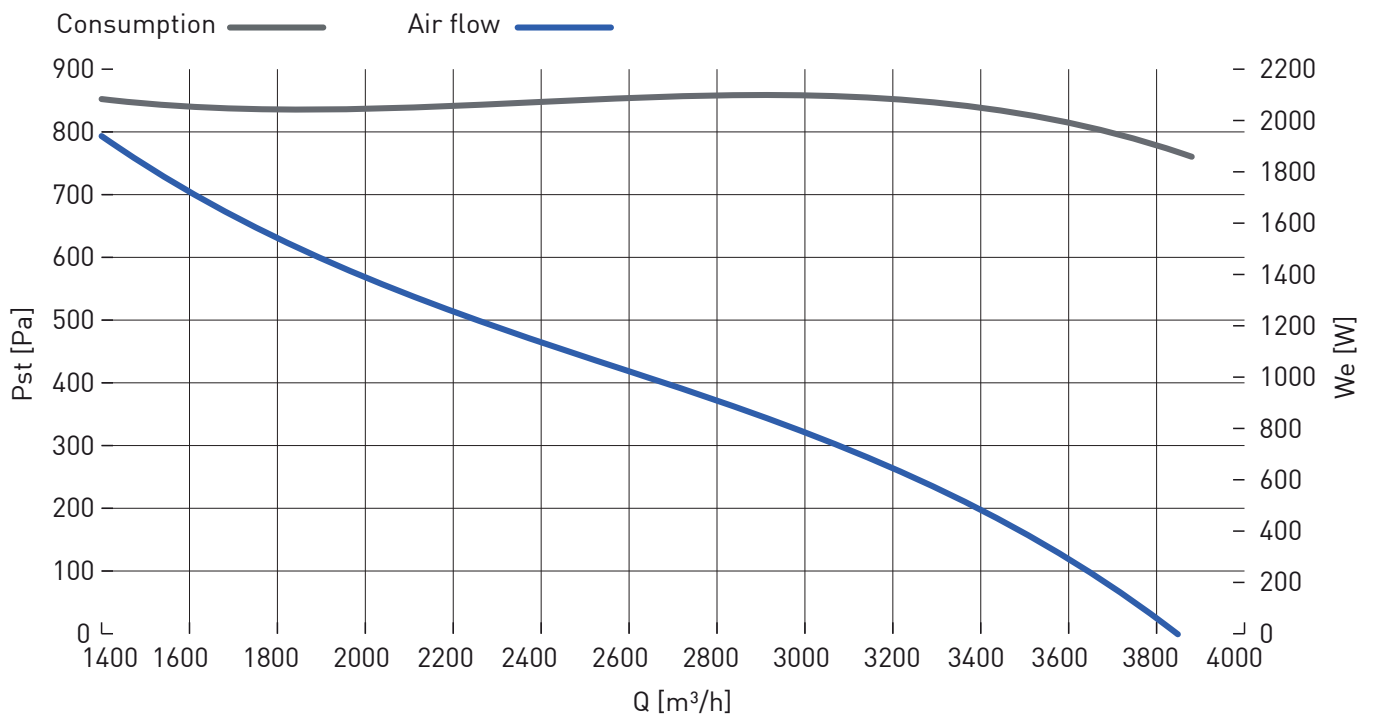

THERMAL EFFICIENCY OF HEAT RECOVERY

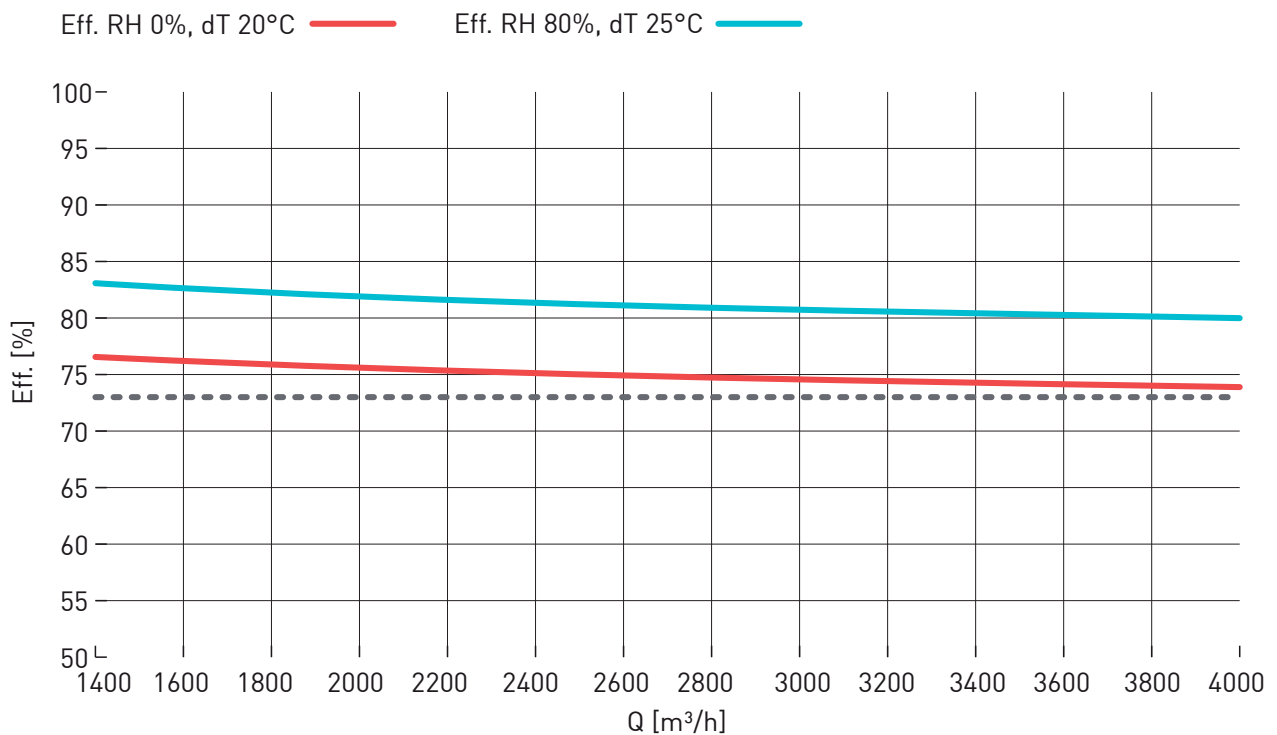

MAXIMUM THERMAL EFFICIENCY OF HEAT RECOVERY (EN 308)

83.0%

External temperature -5 °C - R.H. 80%

Exhaust air +20 °C - R.H. 50%

NOMINAL DATA (DIRECTIVE AND REGULATION NO. 1253/2014 ECODESIGN 2018)

Producer	Fantini Cosmi SpA	
Item N°	AP20085	
Model	UVR 3800 MF HE	
Typology of ventilation unit	UVNR, UVB	
Type of drive	MSD (multiple speed drive)	
Type of heat recovery system	air/air heat recovery system	
Nominal flow rate (qnom)	[m ³ /h]	2760
	[m ³ /s]	0,767
Electrical power input (We,tot)	[W]	2097
Internal specific fan power (SFPint)	[W/(m ³ /s)]	1038
Internal specific fan power, 2018 limit	[W/(m ³ /s)]	1038
Face velocity	[m/s]	1,6
Nominal external pressure ($\Delta p_{s,ext}$)	[Pa]	381
Internal pressure drop of ventilation components ($\Delta p_{s,int}$), mandata	[Pa]	238
Internal pressure drop of ventilation components ($\Delta p_{s,int}$), return	[Pa]	243
Thermal efficiency of HRS (nt, dry air, ΔT 20 [°C])	[%]	74,8
Static efficiency of fan (according Regulation UE n. 327/2011)	[%]	59,8
Casing sound power level (LWA)	[dB]	95
External leakage	max 3,5 @ -400 Pa	(EN 13141-7)
Internal leakage	max 5,5 @ +250 Pa	(EN 13141-7)
Web address	www.fantinosmi.it	
In accordance with the Regulation (UE) N° 1253/2014	2018 compliant product	

CHARACTERISTIC CURVES

AP20087 - UVR 4500 MF HE

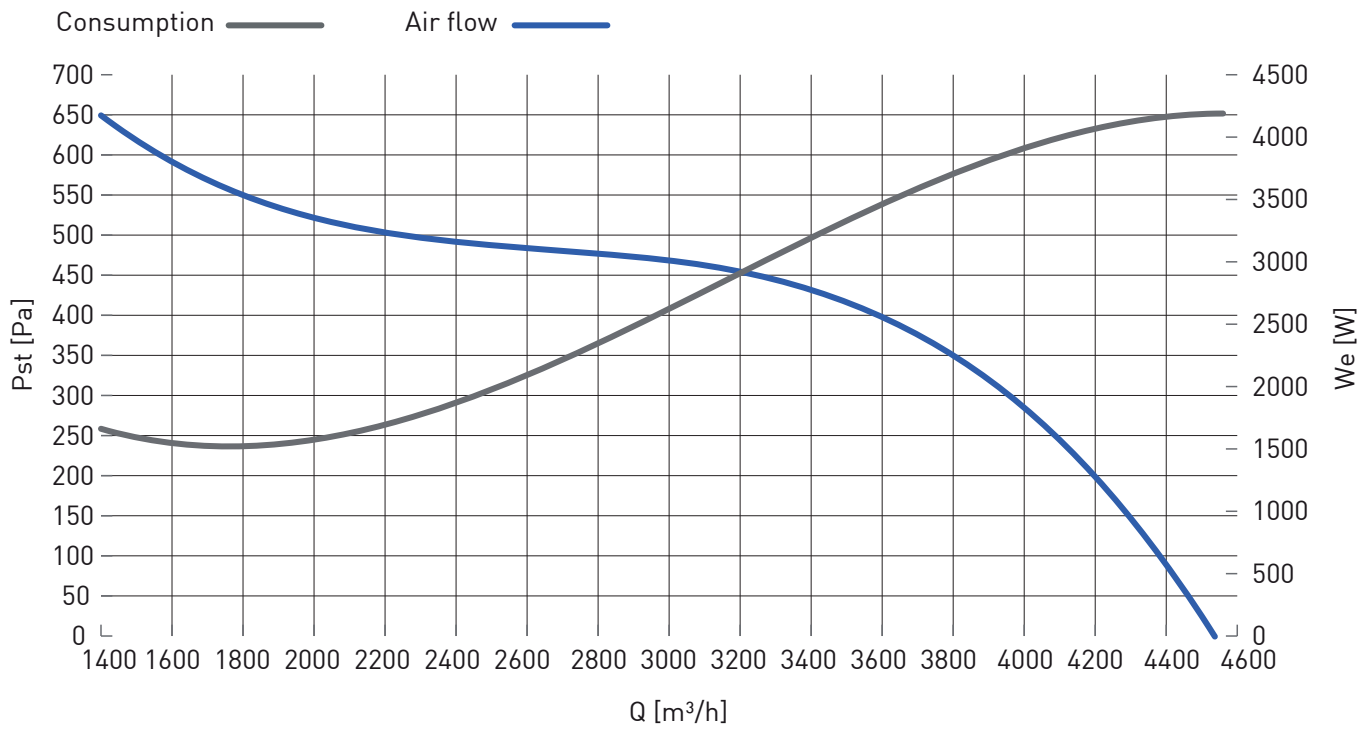

THERMAL EFFICIENCY OF HEAT RECOVERY

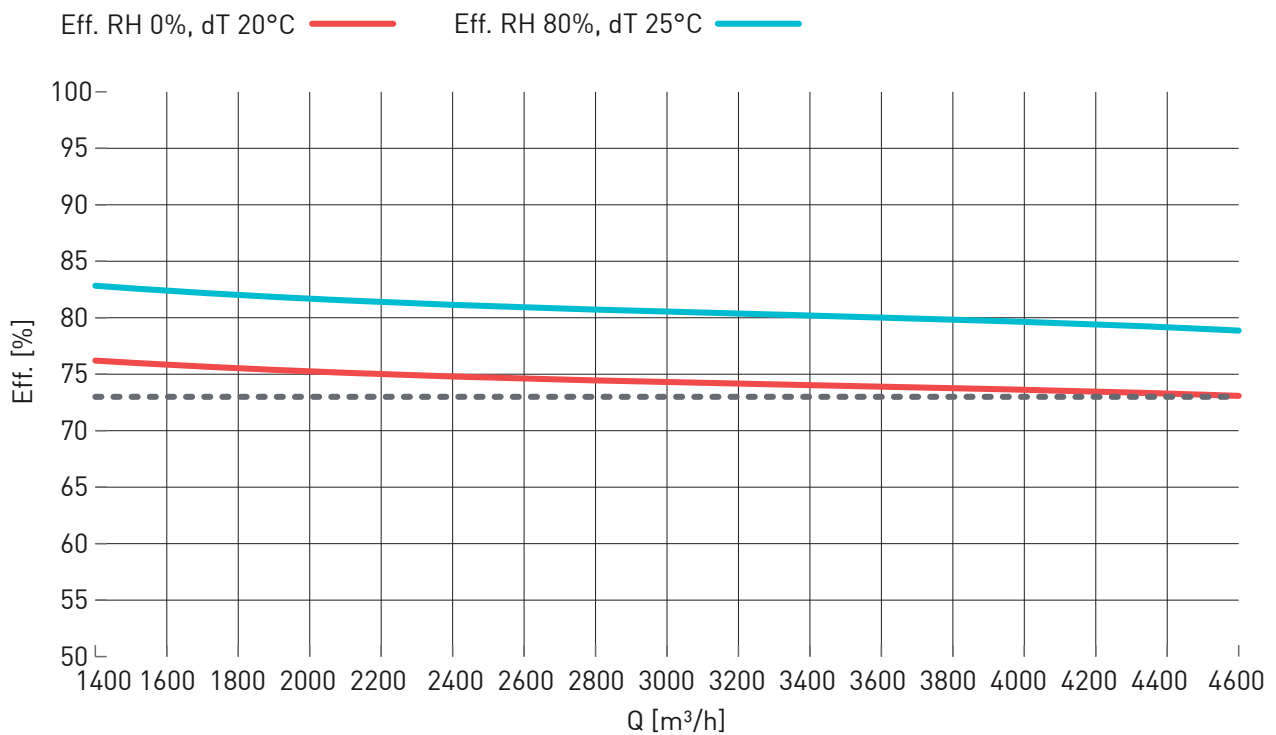

MAXIMUM THERMAL EFFICIENCY OF HEAT RECOVERY (EN 308)

83.0%

External temperature -5 °C - R.H. 80%

Exhaust air +20 °C - R.H. 50%

NOMINAL DATA (DIRECTIVE AND REGULATION NO. 1253/2014 ECODESIGN 2018)

Producer	Fantini Cosmi SpA	
Item N°	AP20087	
Model	UVR 4500 MF HE	
Typology of ventilation unit	UVNR, UVB	
Type of drive	MSD (multiple speed drive)	
Type of heat recovery system	air/air heat recovery system	
Nominal flow rate (qnom)	[m³/h]	2680
	[m³/s]	0,744
Electrical power input (We,tot)	[W]	2192
Internal specific fan power (SFPint)	[W/(m³/s)]	1031
Internal specific fan power, 2018 limit	[W/(m³/s)]	1035
Face velocity	[m/s]	1,7
Nominal external pressure ($\Delta p_{s,ext}$)	[Pa]	481
Internal pressure drop of ventilation components ($\Delta p_{s,int}$), mandata	[Pa]	264
Internal pressure drop of ventilation components ($\Delta p_{s,int}$), return	[Pa]	269
Thermal efficiency of HRS (nt, dry air, ΔT 20 [°C])	[%]	74,6
Static efficiency of fan (according Regulation UE n. 327/2011)	[%]	59,1
Casing sound power level (LWA)	[dB]	100
External leakage	max 3,5 @ -400 Pa	(EN 13141-7)
Internal leakage	max 5,5 @ +250 Pa	(EN 13141-7)
Web address	www.fantincosmi.it	
In accordance with the Regulation (UE) N° 1253/2014	2018 compliant product	

CHARACTERISTIC CURVES

AP20089 - UVR 5400 MF HE

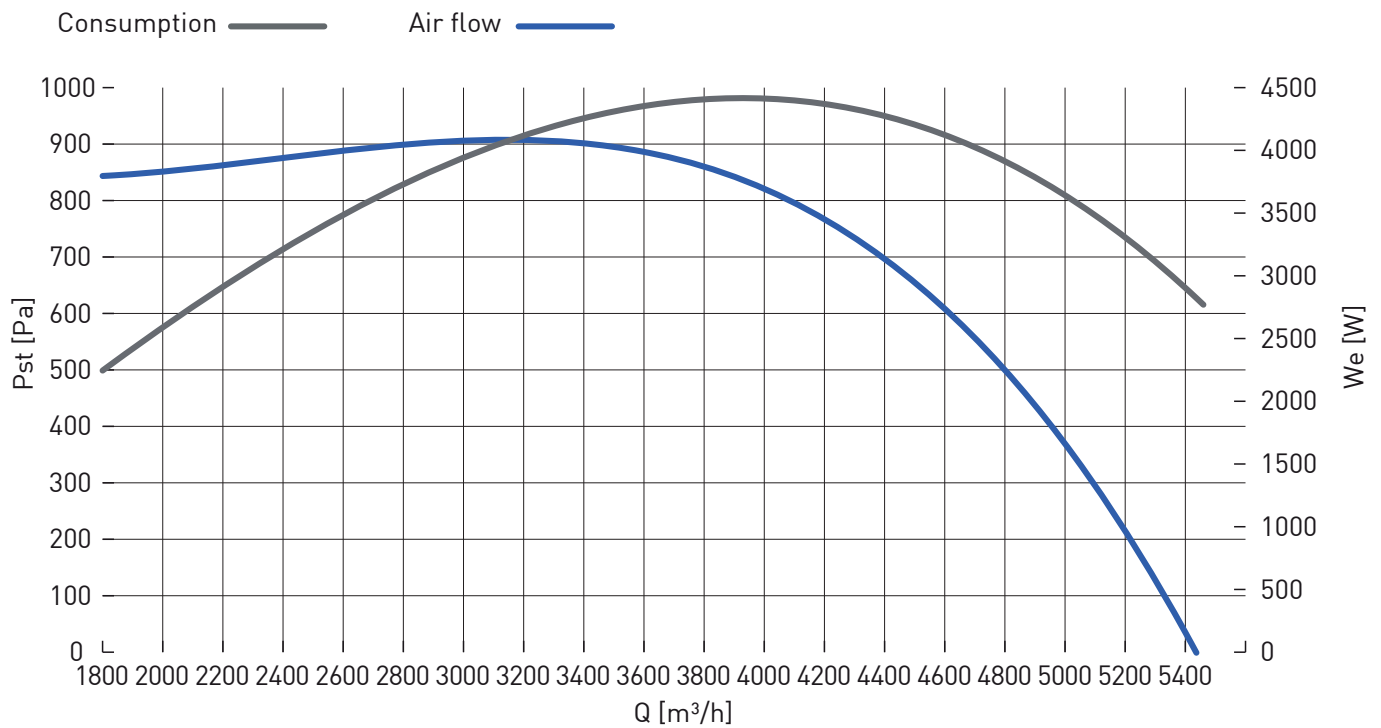

THERMAL EFFICIENCY OF HEAT RECOVERY

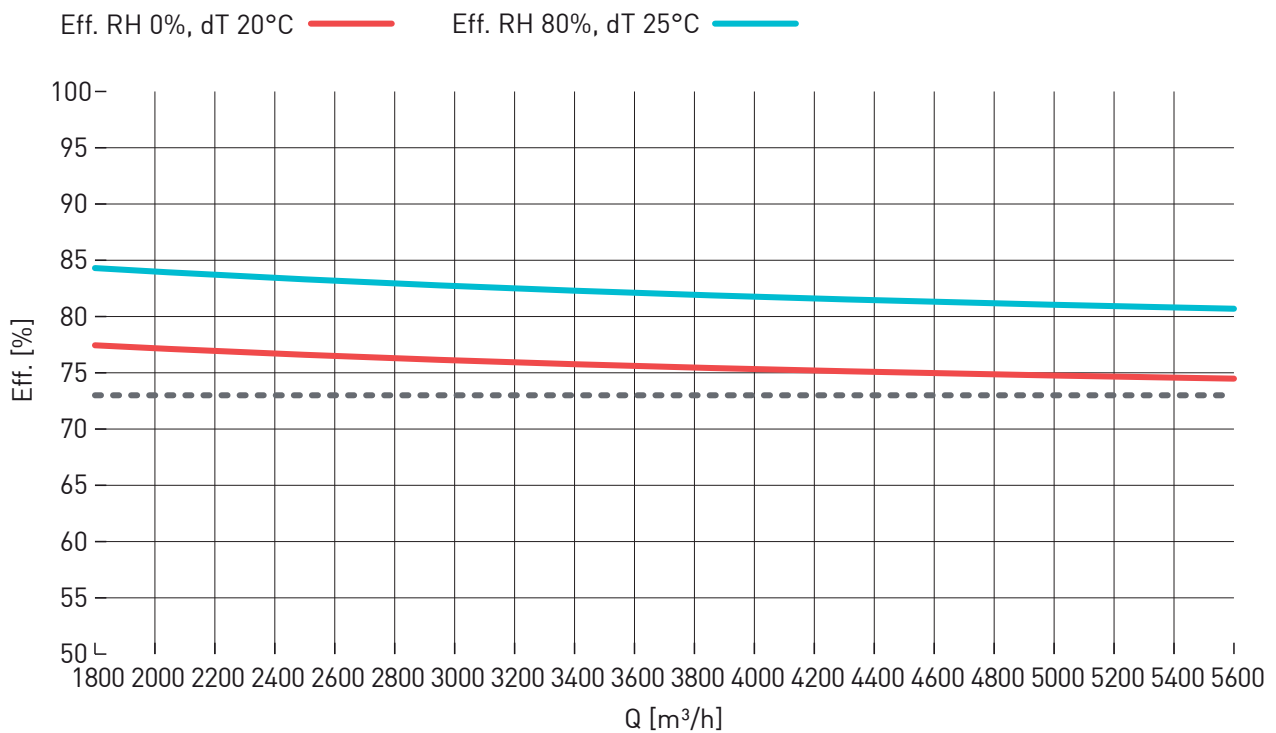

MAXIMUM THERMAL EFFICIENCY OF HEAT RECOVERY (EN 308)

84.0%

External temperature -5 °C - R.H. 80%

Exhaust air +20 °C - R.H. 50%

NOMINAL DATA (DIRECTIVE AND REGULATION NO. 1253/2014 ECODESIGN 2018)

Producer	Fantini Cosmi SpA	
Item N°	AP20089	
Model	UVR 5400 MF HE	
Typology of ventilation unit	UVNR, UVB	
Type of drive	MSD (multiple speed drive)	
Type of heat recovery system	air/air heat recovery system	
Nominal flow rate (qnom)	[m³/h]	4780
	[m³/s]	1,328
Electrical power input (We,tot)	[W]	3937
Internal specific fan power (SFPint)	[W/(m³/s)]	956
Internal specific fan power, 2018 limit	[W/(m³/s)]	957
Face velocity	[m/s]	1,7
Nominal external pressure ($\Delta p_{s,ext}$)	[Pa]	511
Internal pressure drop of ventilation components ($\Delta p_{s,int}$), mandata	[Pa]	248
Internal pressure drop of ventilation components ($\Delta p_{s,int}$), return	[Pa]	253
Thermal efficiency of HRS (nt, dry air, ΔT 20 [°C])	[%]	74,9
Static efficiency of fan (according Regulation UE n. 327/2011)	[%]	61,4
Casing sound power level (LWA)	[dB]	112,0
External leakage	max 3,5 @ -400 Pa	(EN 13141-7)
Internal leakage	max 5,5 @ +250 Pa	(EN 13141-7)
Web address	www.fantinosmi.it	
In accordance with the Regulation (UE) N° 1253/2014	2018 compliant product	

CHARACTERISTIC CURVES

AP20091 - UVR 6500 MF HE

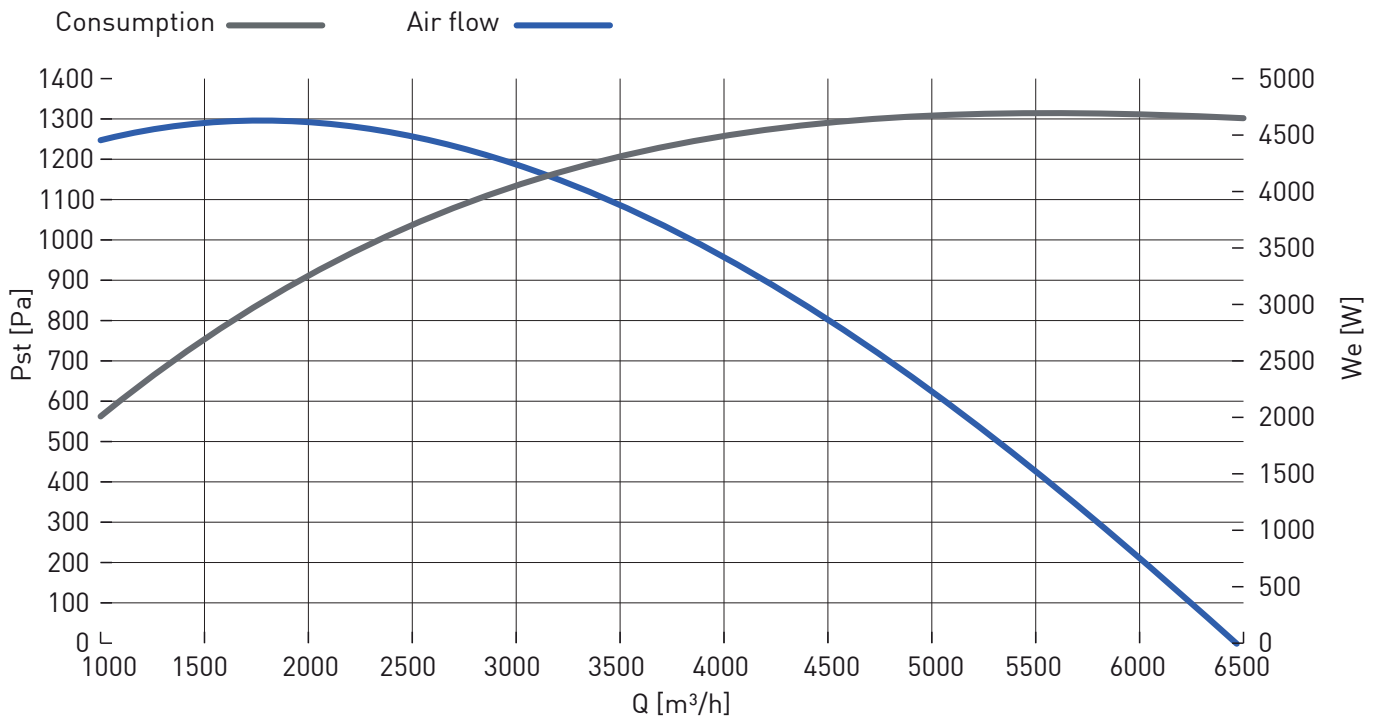

THERMAL EFFICIENCY OF HEAT RECOVERY

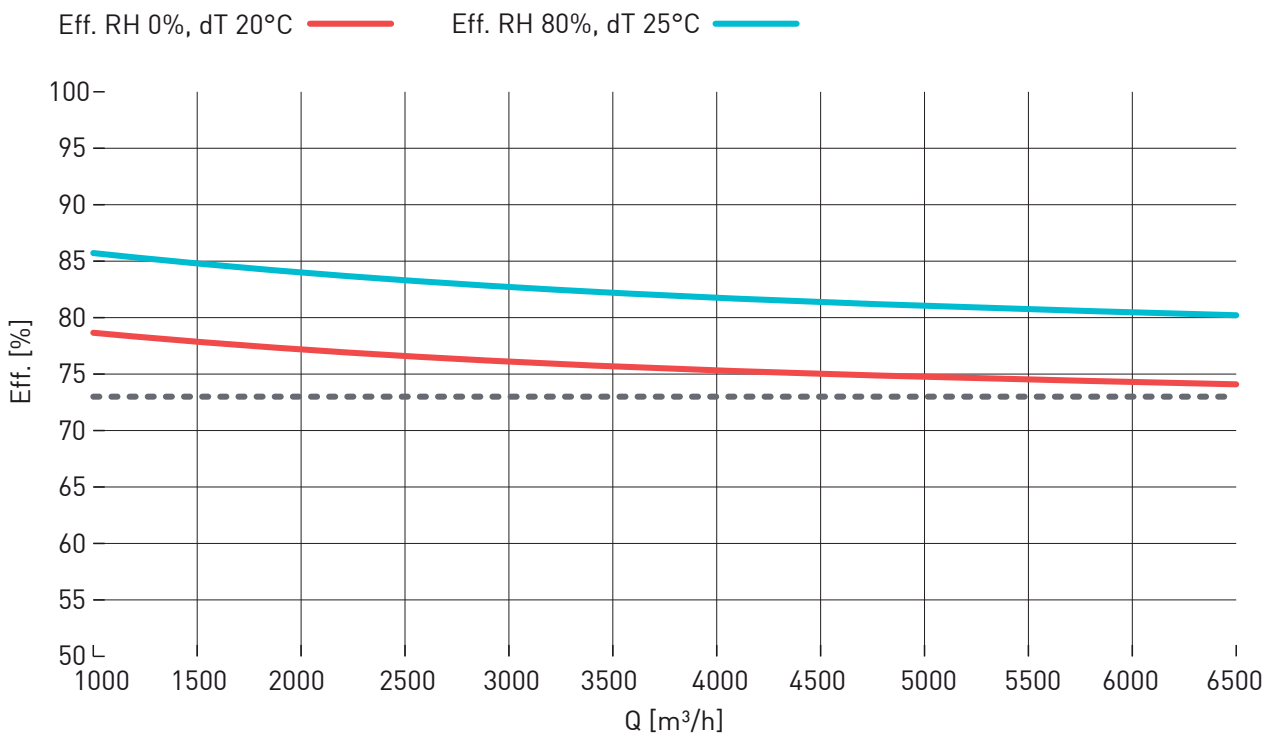

MAXIMUM THERMAL EFFICIENCY OF HEAT RECOVERY (EN 308)

86.0%

External temperature -5 °C - R.H. 80%

Exhaust air +20 °C - R.H. 50%

NOMINAL DATA (DIRECTIVE AND REGULATION NO. 1253/2014 ECODESIGN 2018)

Producer	Fantini Cosmi SpA	
Item N°	AP20091	
Model	UVR 6500 MF HE	
Typology of ventilation unit	UVNR, UVB	
Type of drive	MSD (multiple speed drive)	
Type of heat recovery system	air/air heat recovery system	
Nominal flow rate (qnom)	[m³/h]	4880
	[m³/s]	1,356
Electrical power input (We,tot)	[W]	4662
Internal specific fan power (SFPint)	[W/(m³/s)]	942
Internal specific fan power, 2018 limit	[W/(m³/s)]	951
Face velocity	[m/s]	1,7
Nominal external pressure ($\Delta p_{s,ext}$)	[Pa]	669
Internal pressure drop of ventilation components ($\Delta p_{s,int}$), mandata	[Pa]	257
Internal pressure drop of ventilation components ($\Delta p_{s,int}$), return	[Pa]	261
Thermal efficiency of HRS (nt, dry air, ΔT 20 [°C])	[%]	74,8
Static efficiency of fan (according Regulation UE n. 327/2011)	[%]	62,8
Casing sound power level (LWA)	[dB]	115
External leakage	max 3,5 @ -400 Pa	(EN 13141-7)
Internal leakage	max 5,5 @ +250 Pa	(EN 13141-7)
Web address	www.fantinosmi.it	
In accordance with the Regulation (UE) N° 1253/2014	2018 compliant product	

CHARACTERISTIC CURVES

AP20093 - UVR 7100 MF HE

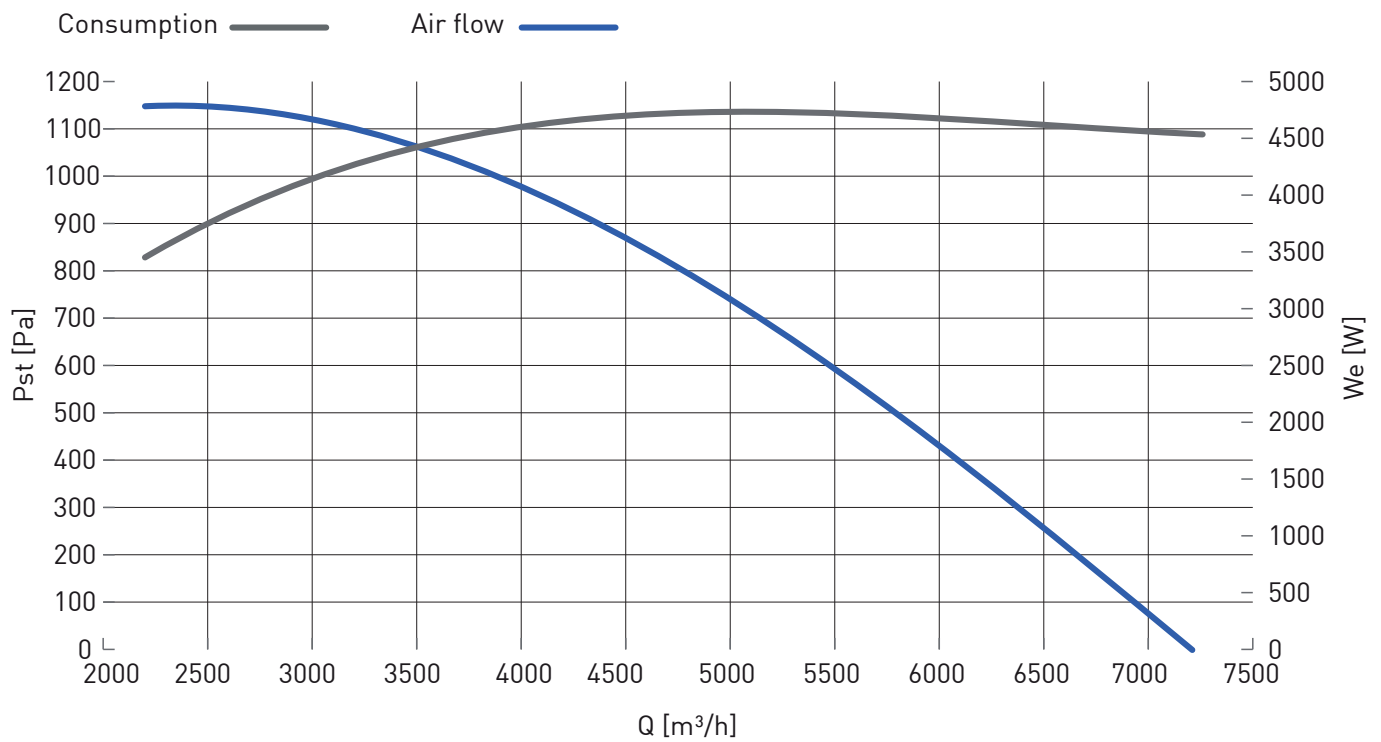

THERMAL EFFICIENCY OF HEAT RECOVERY

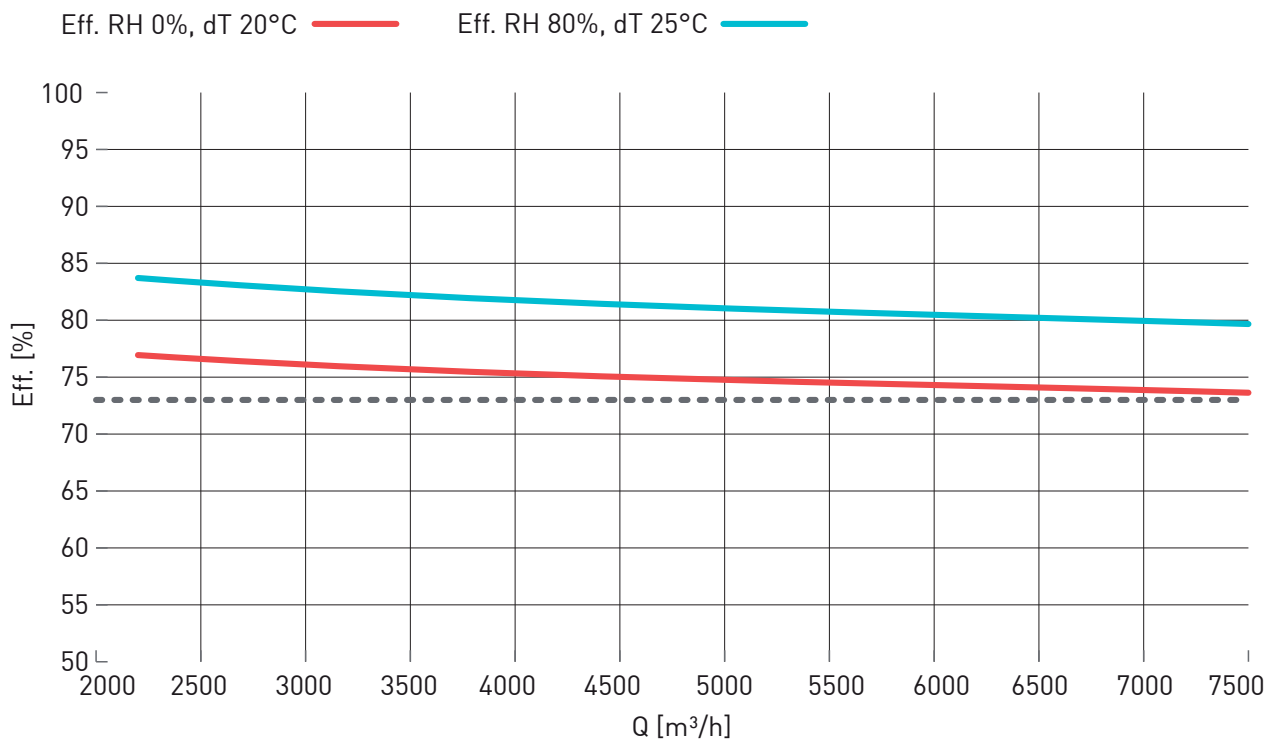

MAXIMUM THERMAL EFFICIENCY OF HEAT RECOVERY (EN 308)

84.0%

External temperature -5 °C - R.H. 80%

Exhaust air +20 °C - R.H. 50%

NOMINAL DATA (DIRECTIVE AND REGULATION NO. 1253/2014 ECODESIGN 2018)

Producer	Fantini Cosmi SpA	
Item N°	AP20093	
Model	UVR 7100 MF HE	
Typology of ventilation unit	UVNR, UVB	
Type of drive	MSD (multiple speed drive)	
Type of heat recovery system	air/air heat recovery system	
Nominal flow rate (qnom)	[m³/h]	5140
	[m³/s]	1,428
Electrical power input (We,tot)	[W]	4735
Internal specific fan power (SFPint)	[W/(m³/s)]	935
Internal specific fan power, 2018 limit	[W/(m³/s)]	937
Face velocity	[m/s]	1,8
Nominal external pressure ($\Delta p_{s,ext}$)	[Pa]	700
Internal pressure drop of ventilation components ($\Delta p_{s,int}$), mandata	[Pa]	279
Internal pressure drop of ventilation components ($\Delta p_{s,int}$), return	[Pa]	285
Thermal efficiency of HRS (nt, dry air, ΔT 20 [°C])	[%]	74,7
Static efficiency of fan (according Regulation UE n. 327/2011)	[%]	65,5
Casing sound power level (LWA)	[dB]	116
External leakage	max 3,5 @ -400 Pa	(EN 13141-7)
Internal leakage	max 5,5 @ +250 Pa	(EN 13141-7)
Web address	www.fantinosmi.it	
In accordance with the Regulation (UE) N° 1253/2014	2018 compliant product	

CHARACTERISTIC CURVES

AP20095 - UVR 8500 MF HE

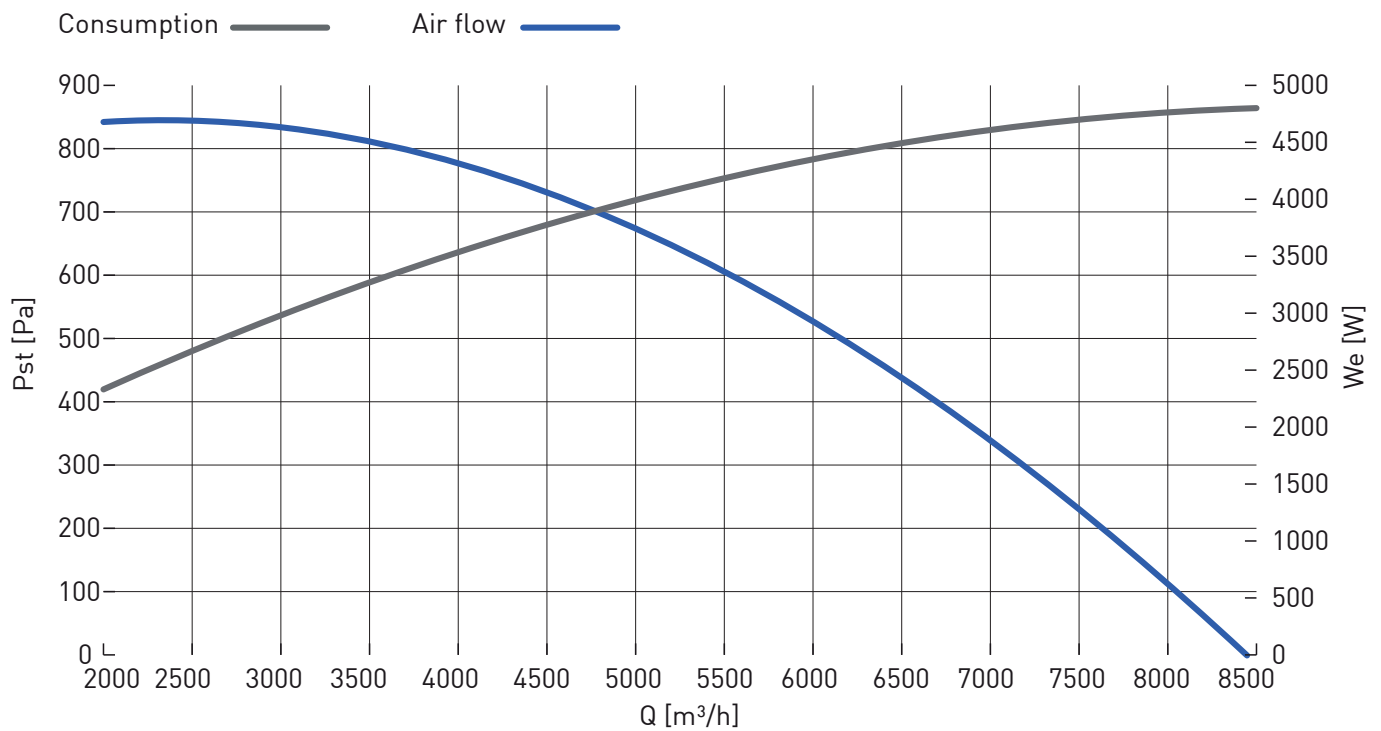

THERMAL EFFICIENCY OF HEAT RECOVERY

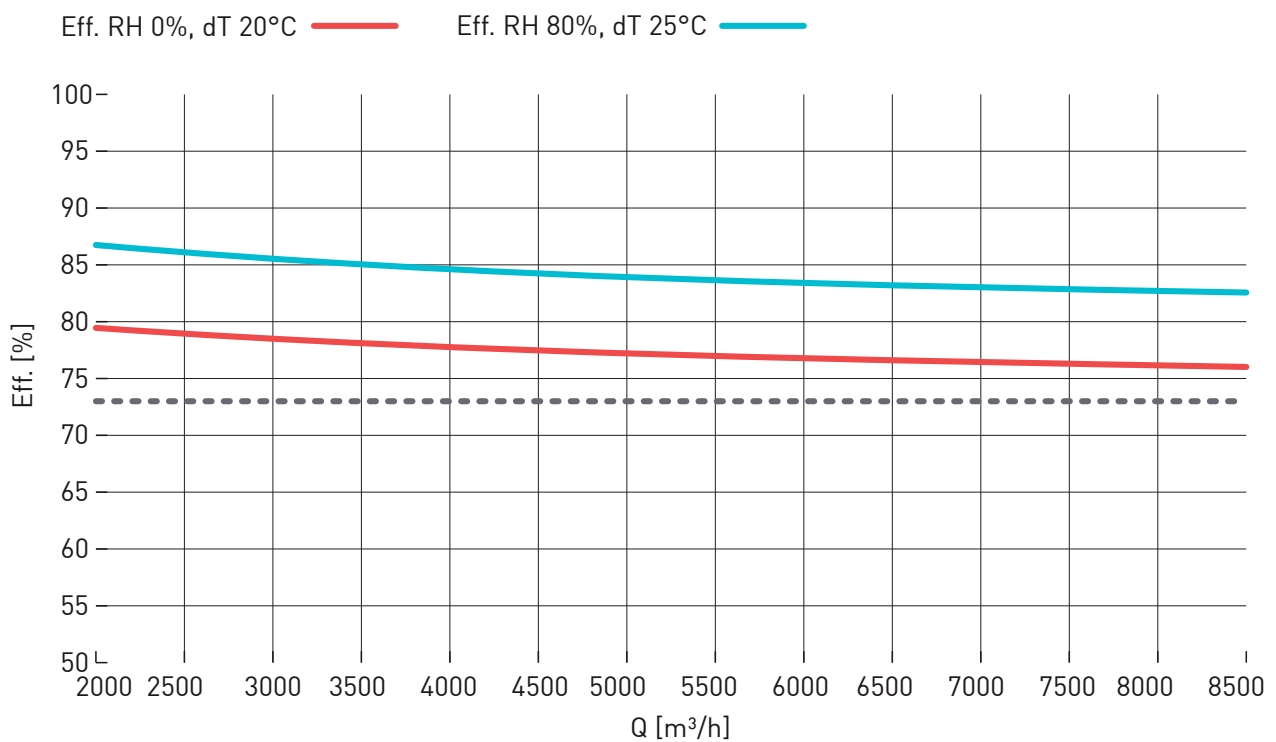

MAXIMUM THERMAL EFFICIENCY OF HEAT RECOVERY (EN 308)

86.0%

External temperature -5 °C - R.H. 80%

Exhaust air +20 °C - R.H. 50%

NOMINAL DATA (DIRECTIVE AND REGULATION NO. 1253/2014 ECODESIGN 2018)

Producer	Fantini Cosmi SpA	
Item N°	AP20095	
Model	UVR 8500 MF HE	
Typology of ventilation unit	UVNR, UVB	
Type of drive	MSD (multiple speed drive)	
Type of heat recovery system	air/air heat recovery system	
Nominal flow rate (qnom)	[m ³ /h]	6460
	[m ³ /s]	1,794
Electrical power input (We,tot)	[W]	4482
Internal specific fan power (SFPint)	[W/(m ³ /s)]	938
Internal specific fan power, 2018 limit	[W/(m ³ /s)]	939
Face velocity	[m/s]	1,7
Nominal external pressure (Δps,ext)	[Pa]	445
Internal pressure drop of ventilation components (Δ ps,int), mandata	[Pa]	273
Internal pressure drop of ventilation components (Δ ps,int), return	[Pa]	278
Thermal efficiency of HRS (nt, dry air, ΔT 20 [°C])	[%]	76,6
Static efficiency of fan (according Regulation UE n. 327/2011)	[%]	66,2
Casing sound power level (LWA)	[dB]	116
External leakage	max 3,5 @ -400 Pa	(EN 13141-7)
Internal leakage	max 5,5 @ +250 Pa	(EN 13141-7)
Web address	www.fantinosmi.it	
In accordance with the Regulation (UE) N° 1253/2014	2018 compliant product	

ACCESSORIES

HOT WATER BATTERY

CODE	MODEL	FOR	Ø battery connection
AP20100	BAC 5	UVR 500 MF HE	1"
		UVR 700 MF HE	
AP20105	BAC 10	UVR 1200 MF HE	1"
AP20110	BAC 14	UVR 1600 MF HE	1"
AP20115	BAC 20-30	UVR 2300 MF HE	3/4"
		UVR 2800 MF HE	
		UVR 3200 MF HE	
AP20120	BAC 35-42	UVR 3800 MF HE	1"
		UVR 4500 MF HE	
AP20125	BAC 55	UVR 5400 MF HE	1"
AP20130	BAC 65-70	UVR 6500 MF HE	2"



DIMENSIONS

MODEL	mm			
	A	B	C	ØD
BAC 5	410	350	300	150
BAC 10	410	350	300	180
BAC 14	620	350	300	250
BAC 20-30	670	410	300	315
BAC 35-42	790	410	300	350
BAC 55	790	530	300	350
BAC 65-70	1170	650	400	450

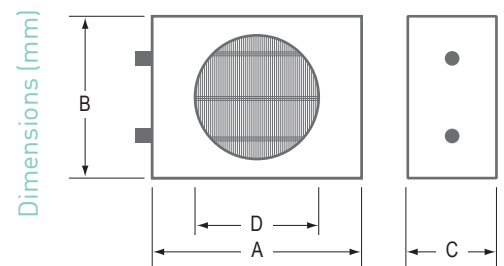

COLD WATER BATTERY

CODE	MODEL	FOR	Ø battery connection
AP20200	BAF 5	UVR 500 MF HE	3/4"
		UVR 700 MF HE	
AP20205	BAF 10	UVR 1200 MF HE	3/4"
AP20210	BAF 14	UVR 1600 MF HE	1"
AP20215	BAF 20-30	UVR 2300 MF HE	1"
		UVR 2800 MF HE	
		UVR 3200 MF HE	
AP20220	BAF 35-42	UVR 3800 MF HE	3/4"
		UVR 4500 MF HE	3/4"
AP20225	BAF 55	UVR 5400 MF HE	3/4"
AP20230	BAF 65-70	UVR 6500 MF HE	3/4"



DIMENSIONS

MODEL	mm			
	A	B	C	Ø
BAF 5	410	350	300	150
BAF 10	410	350	300	180
BAF 14	620	350	300	250
BAF 20-30	670	410	300	315
BAF 35-42	790	410	300	350
BAF 55	790	530	300	350
BAF 65-70	1170	650	400	450

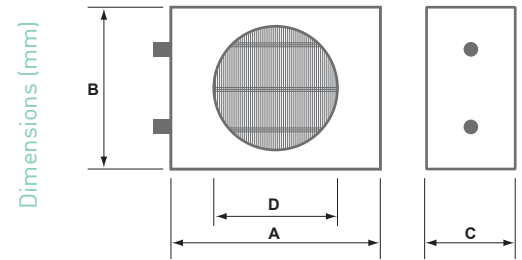

HEATING BOX

Galvanized steel sheet heating box provided with 230V - 50Hz single-phase electrical resistance and control thermostat.

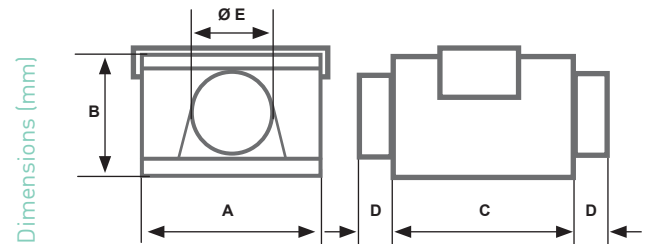

CODE	MODEL	A	B	C	D	ØE	Watt	Kg	FOR
AP19422	BRL 150	300	200	260	80	150	3000	6	UVR 500 MF HE, UVR 700 MF HE
AP19424	BRL 250	350	280	260	80	250	4000	7	UVR 1200 MF HE, UVR 1600 MF HE
AP19425	BRL 315	400	350	260	80	315	4000	9	UVR 2300 MF HE, UVR 2800 MF HE, UVR 3200 MF HE

F8 EXTERNAL FILTER MODULE

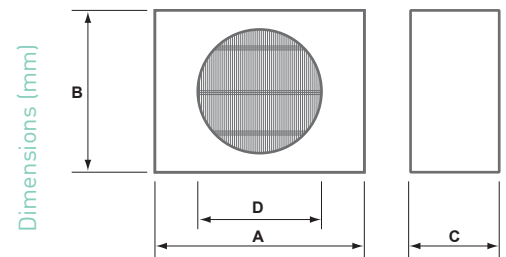

CODE	MODEL	mm				FILTER DIMENSIONS	FOR
		A	B	C	Ø		
AP20400	BF 5	340	240	200	150	340 x 240 x 25	UVR 500 MF HE, UVR 700 MF HE
AP20405	BF 10	340	300	200	180	340 x 300 x 25	UVR 1200 MF HE
AP20410	BF 14	450	340	200	250	450 x 340 x 25	UVR 1600 MF HE
AP20415	BF 20-30	500	400	200	315	500 x 400 x 48	UVR 2300 MF HE, UVR 2800 MF HE, UVR 3200 MF HE
AP20420	BF 35-55	630	500	200	350	625 x 500 x 48	UVR 3800 MF HE, UVR 4500 MF HE, UVR 5400 MF HE

COVER

CODE	MODEL	mm		FOR
		width	depth	
AP20500	TP 5-10	850	850	UVR 500 MF HE
AP20510	TP 20	1150	1150	UVR 700 MF HE UVR 1200 MF HE
AP20515	TP 30	1350	1350	UVR 1600 MF HE UVR 2300 MF HE UVR 2800 MF HE UVR 3200 MF HE UVR 3800 MF HE UVR 4500 MF HE

