

C08

Immersion thermostats with metallic shank

Control thermostats suitable for heating systems, bathrooms, drying boxes, etc.



Dimensions (mm)

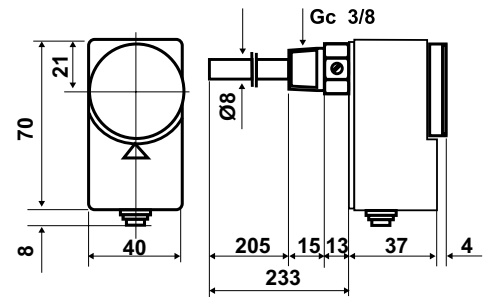

	Temperature range	Differential*	Calibration accuracy	Admissible body temperature	Maximum bulb temperature	Protection degree
C08A	0 ÷ 110 °C	6 ± 1 K	± 3 °C	85 °C	150 °C	IP40
C08B	90 ÷ 200 °C	6 ± 2 K	± 3 °C	85 °C	250 °C	IP40

*The differential is subtracted from the range value. The differential values refer to a thermal gradient of 1K/hour in liquid and 4K/hour in air.

ELECTRICAL FEATURES

Two directions microswitch of instant action with AGcdO contacts.
 Contact parameters in compliance with EN 60730-1: 15(6)A 250V~ 50Hz.
 Parameters in compliance with EN 60947-5-1:

Nominal insulation voltage: U_i 380V~.
 Nominal continuous current: I_{th} 15A.
 Nominal operating current I_e : 220V~ 250V~ 380V~
 Resistive load AC-12 - 15A 10A
 Inductive load AC-15 - 2,5A 1,5A
 Direct current DC-13 0,2A - -

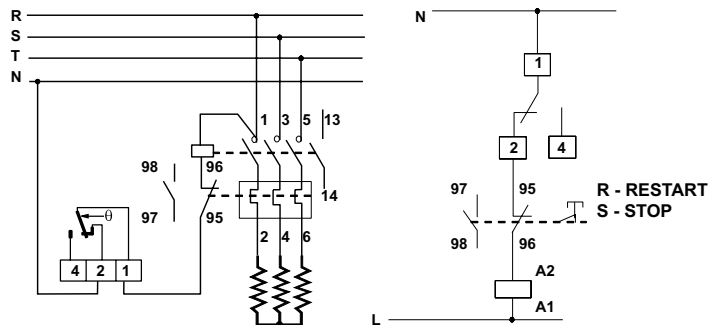
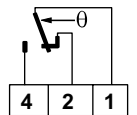

STANDARDS AND APPROVALS

Compliance with standards EN 60947-5-1, EN 60730-1



INSTALLATION

Immersion mounting with threaded brass sheath with connection GC 3/8-PN10 (included in the package).
Is required Gc 1/2" sheath, code G25.

FEATURES

Bimetal (invar-brass) sensing element.
Brass protection sheath with connection Gc 3/8- PN10.
Base, cover and knob in shock-proof self-extinguishing thermoplastic material V0.
Electrical connection output with PVC cable gland.
The storage and transport temperature: $-35 \div 120^{\circ}\text{C}$.
Unit weight: 0,26 Kg.

OPERATION

When the temperature increases: 1-2 are opening, 1-4 are closing.
Bimetal operation.

ACCESSORIES



303298LA
Cable gland G1/2 for connection output in shock-proof self-extinguishing thermoplastic material V0.



G25
Copper sheath GC 3/8 PN10 bar, length 220 mm, Ø 8mm.