

# ASPIRVELO AIR ECOCOMFORT 2.0 SMART series

## SINGLE ROOM HEAT RECOVERY UNIT WITH SMART FUNCTIONS AND ARTIFICIAL INTELLIGENCE

- Nominal diameter Ø 160 mm
- WIFI and Bluetooth Low Energy 5.0 multi-connectivity system
- Air flow temperature, room temperature, relative humidity, brightness, air quality and VOC sensors
- SMART functions
- Setting and remote control by App
- Mounting on outer walls
- Suitable for rooms up to 36 sqm\*
- High efficiency generative ceramic heat exchanger up to 90%
- Summer Free Cooling
- Low noise level ( $D_{2mnTw}$ ) 40dB



\* Data based on:  
- air exchange equal to 0.5 Vol/h  
- local height 2.70 meters  
Calculation example: ambient surface x 2.70 meters x 0.5 Vol/h

(\*) presently available only in Italy / Italian language.

ECOCOMFORT 2.0 SMART system consists of one or more decentralized ventilation heat recovery units at a very high efficiency, to be installed on the outer walls. The generative ceramic heat exchanger stores the heat coming from the exhausted air flow and releases warm air during the intake cycle, after going through a ISO Coarse filter, retaining the impurities.

Each ventilating unit is equipped with a DC brushless motor with low power consumption. Such motor is controlled by a microprocessor which automatically sets the speed modes according to the temperature, humidity, brightness, VOC and thanks to the commands coming from the Intelliclima+ App. These actions guarantee a better air quality and the best comfort to the user.

Minimum installing configuration is the "Master Unit", that can be also connected to additional "Satellite units".

ECOCOMFORT 2.0 SMART multi-connectivity system is integrated with the Intelliclima+ App, which can manage the ventilation system functioning, as well as the complete range of Fantini Cosmi programmable thermostats, with the aim to have an "integrated" Smart Home System.

## TECHNICAL FEATURES

CODE	MODEL	ND Ø TUBE	Room max dimensions	Speed	m <sup>3</sup> /h	Max power absorption W	Power Supply	D2mnTw **	dB(A) 1,5 mt	dB(A) 3 mt
AP19992	ECOCOMFORT 2.0 SMART	160 mm	36 sqm*	V1	20,5	2,5	230V~ 50Hz	40dB	18,5	12,5
				V2	35	4			26,5	20,5
				V3	48,5	6,3			32,5	26,5
				V sleep	8	2			nd	nd

\*Data based on: air exchange equal to 0.5 Vol / h and local height 2.70 meters

Calculation example: ambient surface x 2.70 meters x 0.5 Vol / h

By increasing the number of slave units it is possible to increase the coverage in square meters.

\*\* Noise reduction coming from outside, thanks to the AP19981 Kit (in compliance with the Minimum Environmental Criteria about the acoustic comfort).

## DIMENSIONS (mm)

HEAT RECOVERY UNIT

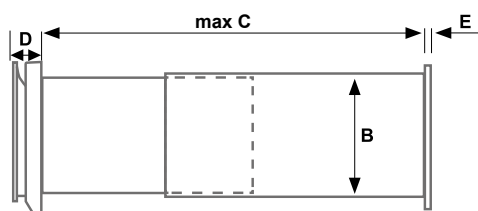
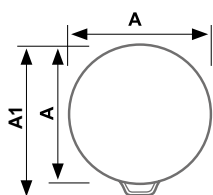

FOLDING  
EXTERNAL GRILLE

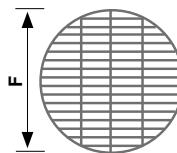

MODEL	A	A1	B	C	D	E	F
ECOCOMFORT 2.0 SMART	230	250	162	280 ÷ 530	55	20	190

## CHARACTERISTICS:

- Plastics made in antistatic and anti UV ABS material;
- Operating temperature -20°C ÷ 50°C;
- Compact dimensions and easy to install;
- Multifunction button with multicolor LED;
- Telescopic body suitable for every wall thickness;
- Folding external grille for internal or external mounting;
- ISO Coarse class filters, according to UNI EN ISO 16890:2017;
- Panel for acoustic, thermal and anti-condensation;
- Flow straightener to guarantee higher performances.

### AP19992 KIT INCLUDES:

- Generative heat recovery unit;
- External grille.

### ACCESSORIES AND SPARE PARTS:

- ISO Coarse class filters, according to UNI EN ISO 16890:2017 (AP1984);
- Panel for acoustic, thermal and anti-condensation insulation (AP1985)
- Windproof and rainproof grille(cod. AP1612);
- Silencer Kit (cod. AP19881).

## HEAT RECOVERY UNIT

- Helical ventilating unit with DC Brushless motor;
- PVC shockproof telescopic tube;
- Generative ceramic heat exchanger with efficiency up to 90%;
- Melamine filter, ISO Coarse filter class, according to UNI EN ISO 16890:2017;
- Flow straightener to guarantee higher performances;
- Power supply 230V~ 50Hz;
- Brightness and humidity sensors;
- Air flow temperature sensor;
- VOC indoor air quality sensor;
- Transceiver frequency: WIFI 2,4 GHz;  
Bluetooth Low Energy 2,4 GHz;
- Protection degree: IPX4;
- FW updating via APP.

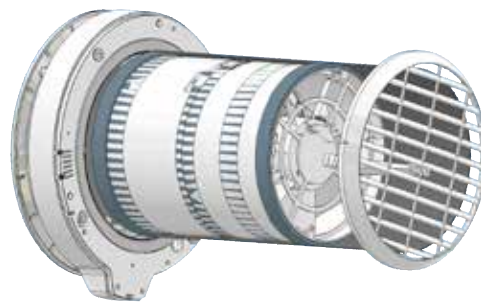

## INSTALLATION

ECOCOMFORT 2.0 SMART must be installed on the outer walls.

Thanks to the telescopic tube, it fits easily every wall thickness between 28 cm (\*) and 53 cm.

Its installation is extremely easy and fast thanks to the expansion external grille, that can be also installed from inside.

(\*) With the installation of the AP19881 kit, provide for a minimum wall thickness of 48 cm.

Telescopic tube for a quick installation:  
minimum length 28 cm, maximum length 53 cm



Expansion external grille to be installed from inside

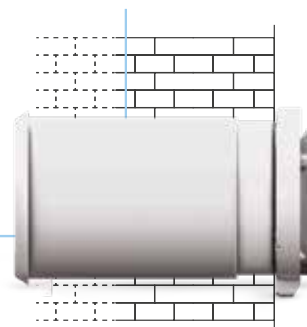

## REMOTE CONTROL VIA APP

ECOCOMFORT 2.0 SMART can be set and managed by smartphone and tablet, through the Intelliclima+ App.

Multi-connectivity system allows to command the ventilation unit, both locally by Bluetooth, than remotely by WIFI.

### ■ EXAMPLE



The **Intelliclima+** APP is available for free on:

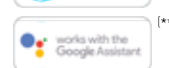



(\*\*) presently available only in Italy / Italian language.



## OPERATION

### ■ MANUAL mode setting:

This mode allows to choose the speed and the functioning cycle settings

-  V3 - high speed
-  V2 - medium speed
-  V1 - low speed

and the functioning cycle setting

-  Air intake (60 minutes temporary mode)
-  Air extraction (60 minutes temporary mode)
-  Alternate air intake / extraction (45 seconds cycle)



Master ventilating unit automatically adjusts the intake/extraction air flow periods, the dehumidification and the speeds according to the ambient parameters detected from the temperature, humidity, VOC and brightness sensors.

### ■ SLEEP mode setting:

-  minimum working speed

### ■ AUTO mode setting:

In the AUTOMATIC mode, Ecocomfort 2.0 SMART works according to the set timing profiles in PROGRAMS, following an alternate input/exhaust air flow with cycles of 45 seconds. The speeds can be modified according to the environmental parameters detected by the temperature, humidity, VOC and brightness sensors.

## ADVANCED FUNCTIONS





ECOCOMFORT 2.0 SMART is a smart ventilating unit for an innovative approach in the environmental comfort management.

Thanks to the continuous parameter monitoring (such as VOC and humidity) and the “Artificial Intelligence” data processing, this system crosses all the useful information to optimize the ventilation system application, anticipating or delaying its activation according to the user behaviours in the ambient and the advanced geolocation, with the aim to provide the best hygrometric well-being and air quality conditions with the lowest possible consumption.

Thanks to this new advanced ventilation approach, the AUTO SMART SENSOR reduces the primary energy requirement through the Intelliclima+ App infographic sections, which displays the system consumption trend and the parameters read by the sensors on board: room temperature, ambient humidity and air quality.

FREE-COOLING mode is also available and can be activated automatically during the summer period, when the external temperature is lower than those internal. This function ensure a greater comfort, as well.

Moreover the ECOCOMFORT 2.0 SMART multi-connectivity system is connected to the Intelliclima+ App as an integrated smart home concept to remotely control the ventilation, heating and cooling systems, or by Google Home™ or Amazon Alexa™<sup>(\*)</sup>.

-  SHARED DYNAMIC GEOLOCATION
-  PERCEIVED TEMPERATURE
-  SENSOR REPORTING DISPLAY
-  SUMMER FREE COOLING
-  AUTO SMART SENSOR
-  VOICE CONTROL <sup>(\*)</sup>
-  REMOTE CONTROL BY APP
-  INTEGRATED WIFI

<sup>(\*)</sup> presently available only in Italy / Italian language.

## ACCESSORIES

### ADDITIONAL VENTILATING UNITS

- ECOCOMFORT 2.0 SMART can be set like a Master Unit or a Satellite Unit, with the same product reference.
- The additional unit can be set choosing the direction of rotation (synchronous or asynchronous to the Master Unit). All the units can be connected by the Bluetooth Low Energy protocol and managed by the Intelliclima+ App.
- All units can be installed in a big ambient or in other rooms.

### SPARE ISO COARSE FILTER

CODE	MODEL
AP1984	FR007



### INSULATING PANEL

CODE	MODEL
AP1985	FR008



### RAINPROOF AND WINDPROOF GRILLE

CODE	MODEL
AP1612	GAP150



### SILENCER KIT

CODE	MODEL
AP19881	SLF160



## HOMOLOGATIONS AND STANDARDS

- Comply with the Directive 2014/53/EU (RED);
- Comply with the Directive 2009/125/CE Energy Related Products (ERP) - Ecodesign 2018;
- Comply with the Regulations: EN 60335-1:2013+A11:2015; EN 60335-2-80:2005+ A2:2009; EN 55014-1:2006+A1:2009+A2:2011; EN55014-2:2015; EN61000-3-2:2014; EN61000-3-3:2013 EN301 489-1 V.1.9.2; EN301 489-7 V.1.3.1 ETSI EN300 220-1 V2.4.1; ETSI EN300 220-2 V2.4.1 UNI EN ISO 10140-2 - UNI EN ISO 717-1



## SPECIFICATIONS

Decentralized ventilation unit with ceramic heat recovery at a very high efficiency with Smart Functions and Artificial Intelligence. Wi-Fi and Bluetooth Low Energy 5.0 multi-connectivity system for the device configuration and management by the Fantini Cosmi Intellimatic+ App. Equipped by air flow temperature sensors, relative humidity, brightness, VOC for the intelligent control of the environmental comfort and the air quality. Multifunction button with multicolour LED. Functioning available in Automatic, Manual, Sleep, OFF modes. Geolocation Smart Functions and Auto Sensor to minimize the consumption, increasing the thermohygrometric comfort. Parameter reporting view read by the sensors; perceived temperature display. Remote management via APP and by Google Home™ and Amazon Alexa™ Smart Speakers (\*).

Installation on perimeter walls with 53 cm maximum thickness. Telescopic tube for walls from 28 to 53 cm. Ceramic heat recovery unit with efficiency up to 90%. DC brushless motor with flow rectifier at a very low consumption. 4 working speeds (minimum, medium, maximum + sleep mode). Rate (20,5 mc/h, 35 mc/h, 48,5 mc/h) + 8 mc/h. Absorbed power (2,5 W, 4W, 6,3 W). SPI 0,12 W/mc/h. Sound pressure @ 3mt 12,5 dB(A), 20,5 dB(A), 26,5 dB(A) Power supply: 230Vac. Facade insulation  $\geq$  40dB. Protection degree IPX4. ISO Coarse melamin filter according to UNI EN ISO 16890:2017 standard. Expansion external grille for internal mounting. Rainproof and windproof external grille. Kit for the external noise reduction. A Class according to the UE Regulation n°1254/2014. Reddot Winner 2021. In compliance with the Directive 2014/53/EU (RED) and Directive 2009/125/CE Energy Related Products (ERP) - Ecodesign 2018; In compliance with the Standards EN 60335-1:2013+A11:2015; EN 60335-2-80:2005+ A2:2009; EN 55014-1:2006+A1:2009+A2:2011; EN55014-2:2015; EN61000-3-2:2014; EN61000-3-3:2013 EN301 489-1 V.1.9.2; EN301 489-7 V.1.3.1 ETSI EN300 220-1 V2.4.1; ETSI EN300 220-2 V2.4.1; UNI EN ISO 10140-2 - UNI EN ISO 717-1.

(\*): presently available only in Italy / Italian language.